

A/C-HEATER SYSTEM TROUBLE SHOOTING - MANUAL

1990 Nissan 240SX

1990 Manual A/C-Heater Systems

240SX

NOTE: This article has been revised as specified in Technical Service Bulletin TS89-160 Dated Nov. 30,1989.

MANUAL A/C-HEATER SYSTEM TROUBLESHOOTING

See MANUAL A/C-HEATER SYSTEM TROUBLESHOOTING CHART below and applicable figures.

MANUAL A/C-HEATER SYSTEM TROUBLESHOOTING CHART

Preliminary Check	Problem/Symptom	Comment
1	Intake door is not set at FRESH in DEFROST or FOOT/DEFROST mode	See Fig. 1
2	A/C Does Not Blow Cold Air	See Fig. 2
3	Compressor (Magnet) Clutch Does Not Operate In DEFROST Mode	See Fig. 3
4	Air outlet does not change	See Fig. 4
5	Noise	See Fig. 5
6	Power Supply Circuit Check For A/C System	See Fig. 6

TROUBLE DIAGNOSES

Preliminary Check (Cont'd)

PRELIMINARY CHECK 2 A/C does not blow cold air.

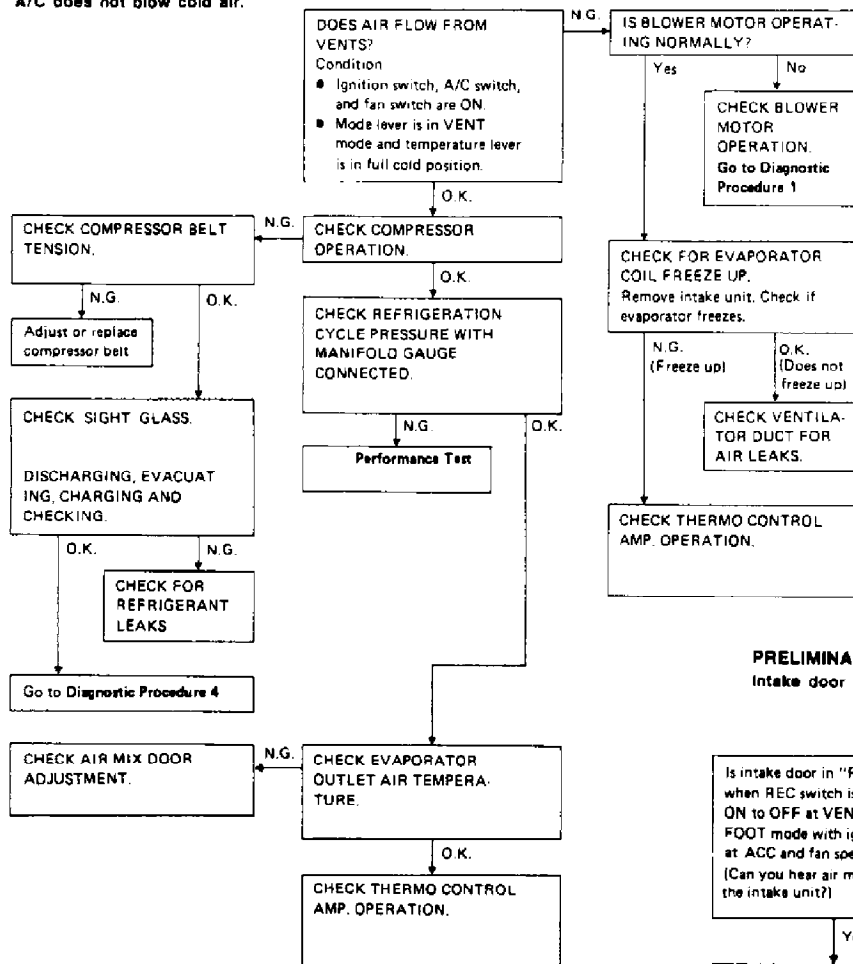

PRELIMINARY CHECK 1

Intake door is not set at "FRESH" in DEF or FOOT mode.

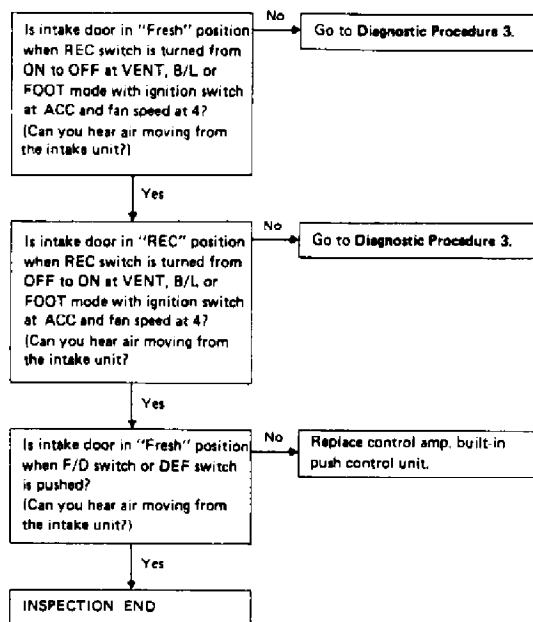

Fig. 1: Preliminary Check 1
Courtesy of Nissan Motor Co., U.S.A.

**PRELIMINARY CHECK 2
A/C DOES NOT BLOW COLD AIR**

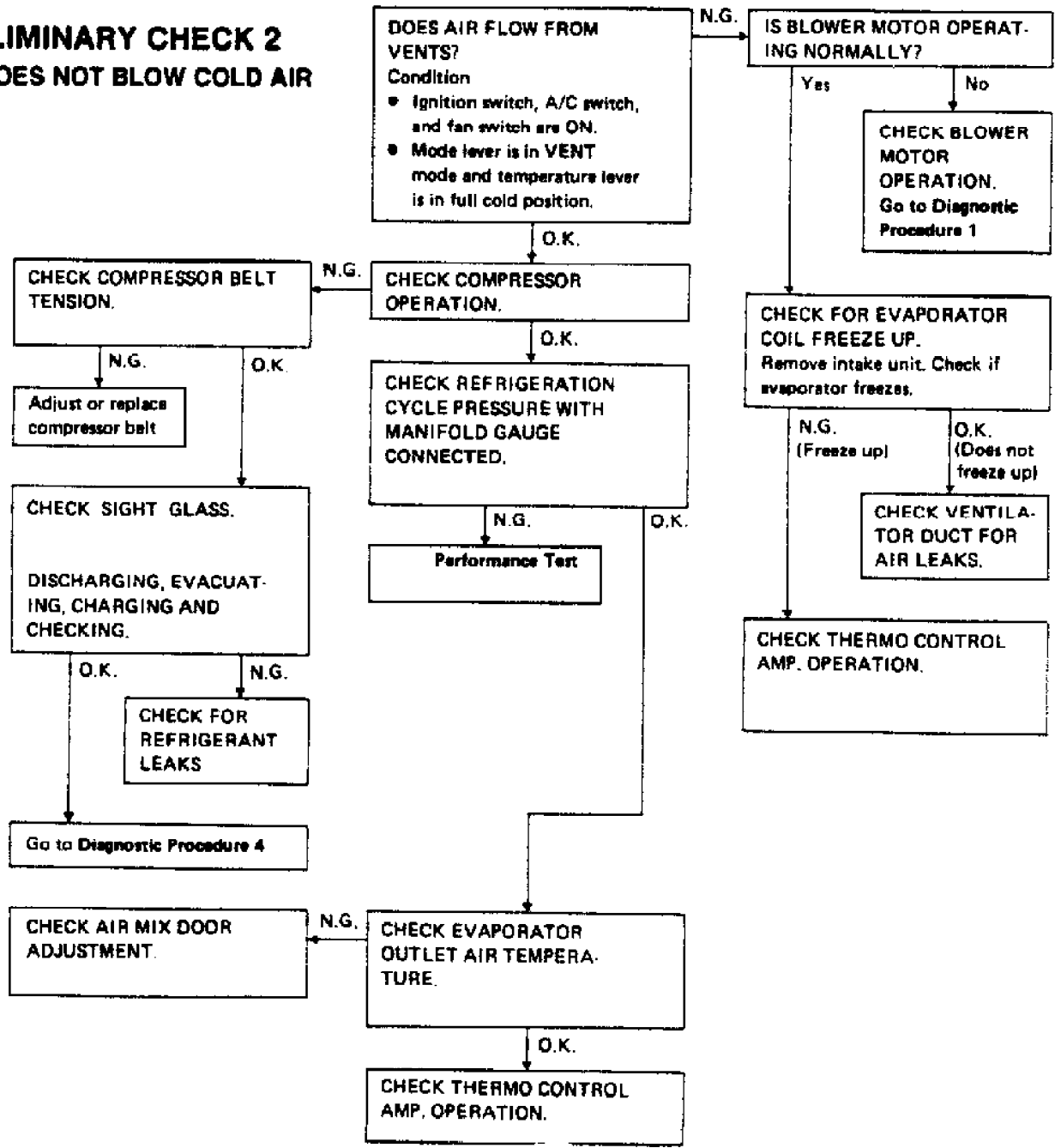

Fig. 2: Preliminary Check 2
Courtesy of Nissan Motor Co., U.S.A.

TROUBLE DIAGNOSES

Preliminary Check (Cont'd)

PRELIMINARY CHECK 4 Air outlet does not change.

DOES AIR COME OUT FROM EACH DUCT NORMALLY WHEN EACH MODE SWITCH IS PUSHED WITH IGNITION SWITCH AT ACC?

		Indicator illuminates					Air outlet
Mode		○					VENT
			○				FOOT & VENT
				○			FOOT & DEF
					○		FOOT & DEF
						○	DEF

Air distribution ratios

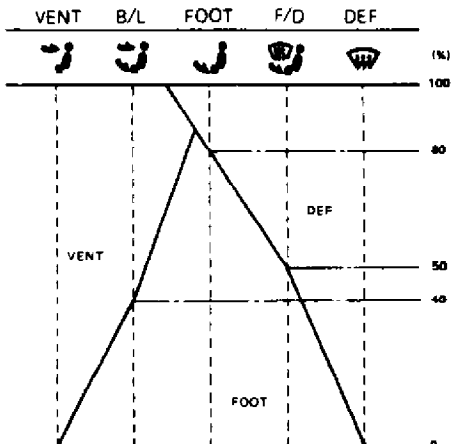

Yes

INSPECTION END

No

Go to Diagnostic Procedure 2.

PRELIMINARY CHECK 3

Magnet clutch does not operate in DEF mode.

● Perform PRELIMINARY CHECK 2 before referring to the following flow chart.

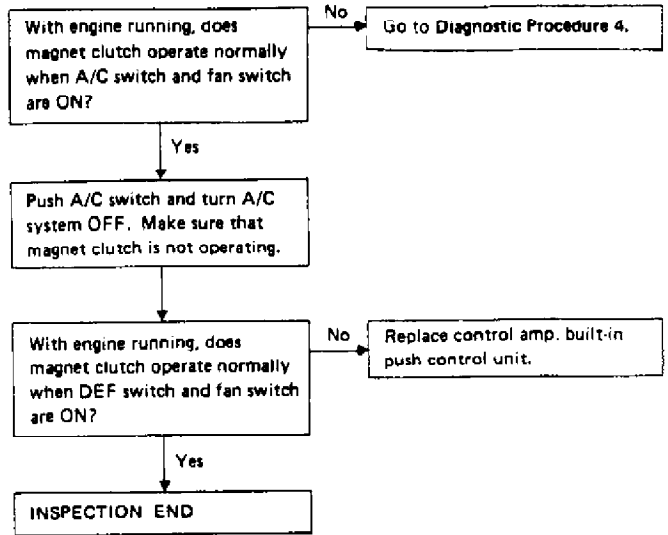









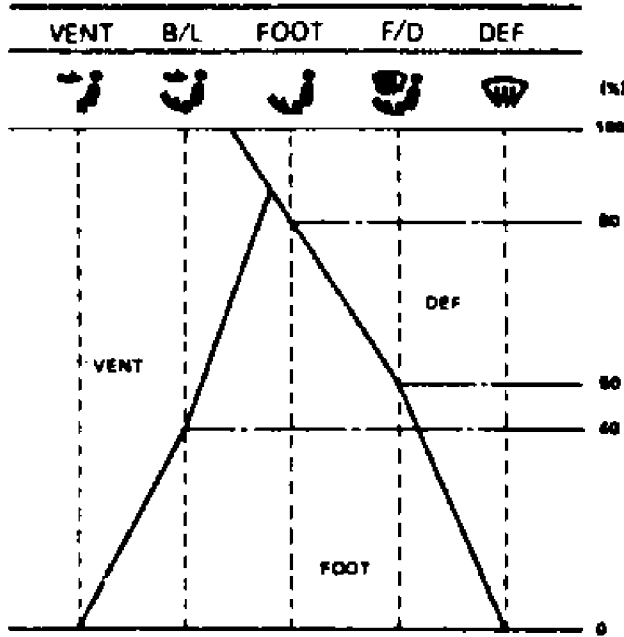

Fig. 3: Preliminary Check 3
Courtesy of Nissan Motor Co., U.S.A.

DOES AIR COME OUT FROM EACH DUCT NORMALLY WHEN EACH MODE SWITCH IS PUSHED WITH IGNITION SWITCH AT ACC?

Switch		Indicator illuminates					Air outlet
							
Mode		○					VENT
			○				FOOT & VENT
				○			FOOT & DEF
					○		FOOT & DEF
						○	DEF

Air distribution ratios



Yes

No

INSPECTION END

Go to Diagnostic Procedure 2.

Fig. 4: Preliminary Check 4
Courtesy of Nissan Motor Co., U.S.A.

PRELIMINARY CHECK 5
Noise

Preliminary Check (Cont'd)

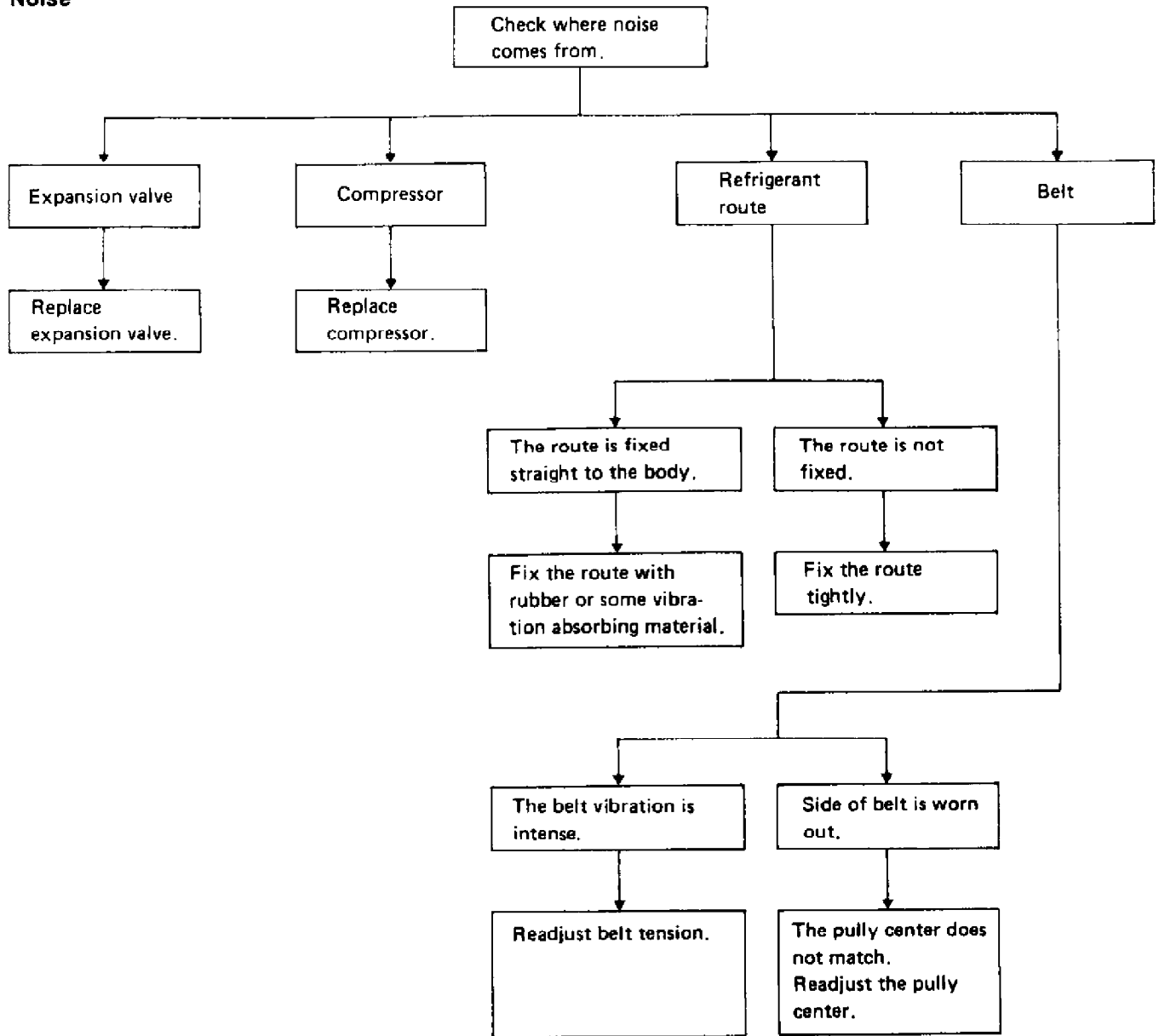

Fig. 5: Preliminary Check 5
Courtesy of Nissan Motor Co., U.S.A.

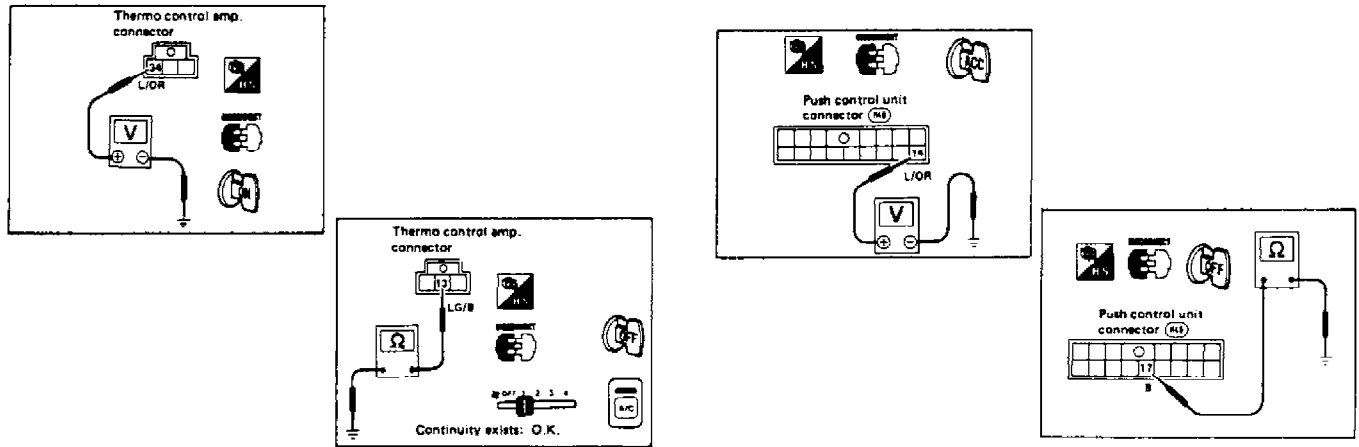

Fig. 6: Preliminary Check 6
 Courtesy of Nissan Motor Co., U.S.A.

PRELIMINARY CHECK 6 POWER SUPPLY CIRCUIT CHECK FOR A/C SYSTEM

Thermo Control Amplifier Check

1. Disconnect thermo control amplifier harness connector.
2. Turn ignition ON. Using voltmeter, ensure battery voltage exists at connector terminal No. 34.
3. Turn ignition OFF. Turn A/C and fan switch ON. Using harness connector terminal No. 13 and ground.

Push Control Unit Check

1. Disconnect push control unit harness connector.
2. Turn ignition switch to ACC position.
3. Using voltmeter, ensure battery voltage exists at terminal No. 14 of harness connector.
4. Turn ignition switch to OFF position.
5. Using ohmmeter, ensure continuity exists between terminal No. 17 of harness connector and ground.

DIAGNOSTIC PROCEDURE 1 - BLOWER MOTOR DOES NOT ROTATE

See Fig. 7 to 9.

	INCIDENT	Flow chart No.
1	Fan fails to rotate.	[1]
2	Fan does not rotate at 1-speed.	[2]
3	Fan does not rotate at 2-speed.	[3]
4	Fan does not rotate at 3-speed.	[4]
5	Fan does not rotate at 4-speed.	5

• Perform PRELIMINARY CHECK 2 before referring to the following flow chart.

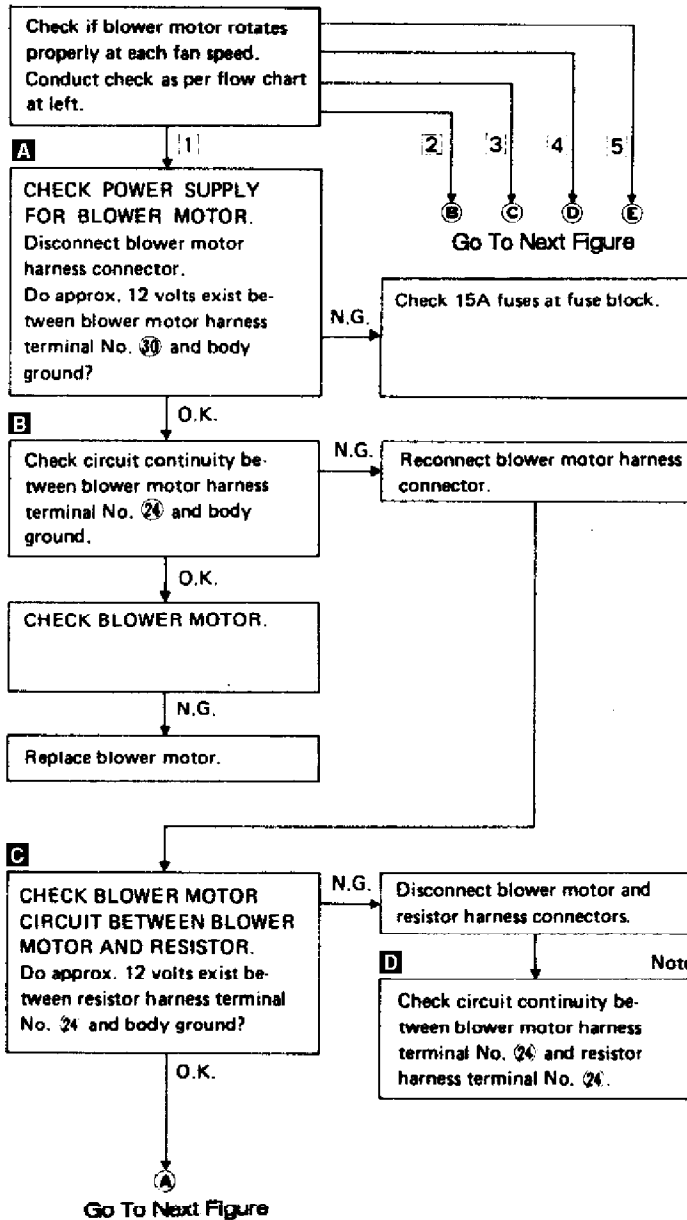
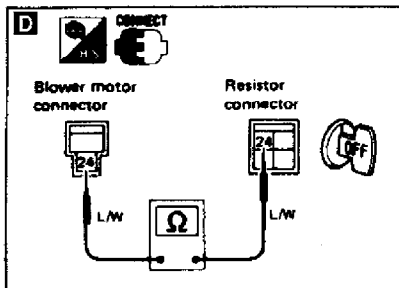
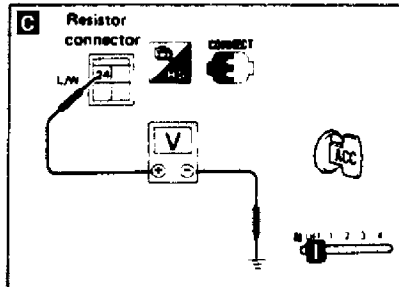
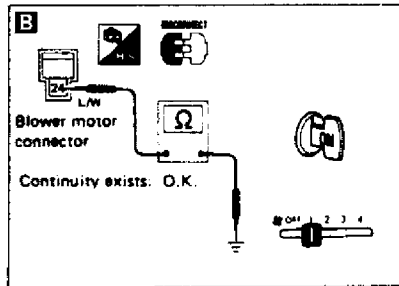
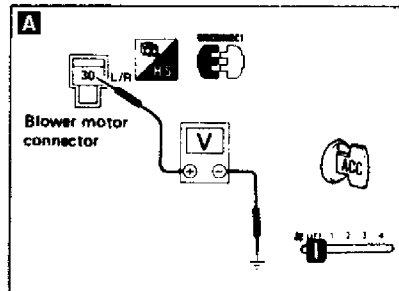

NOTE: If the result is no good (NG) after checking circuit continuity, repair harness or connector.

90F05632

Fig. 7: Diagnostic Procedure 1 (1 of 3)
Courtesy of Nissan Motor Co., U.S.A.

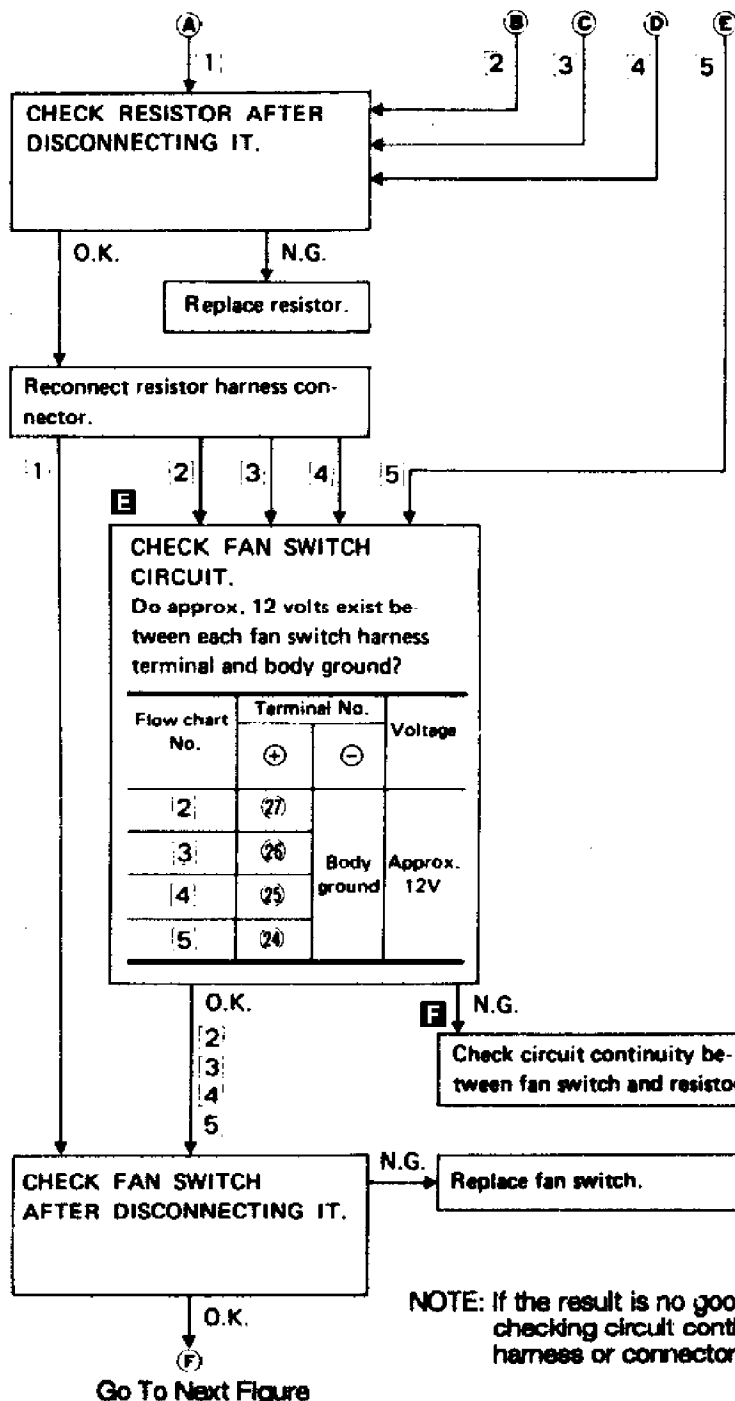
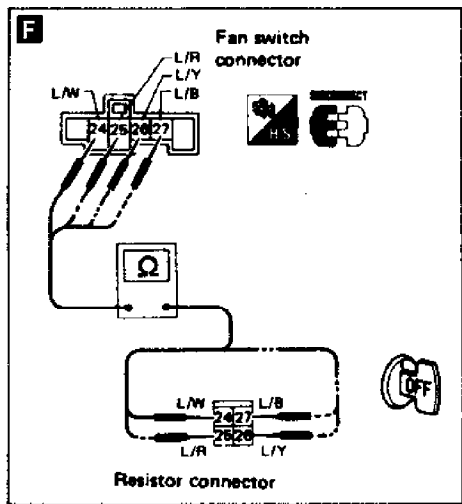
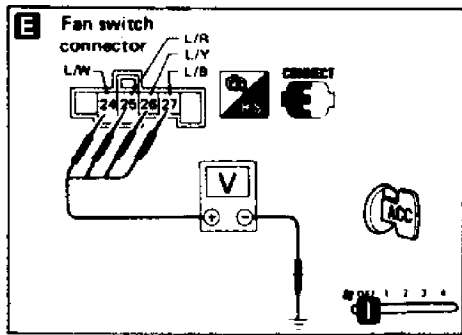

91A04814

Fig. 8: Diagnostic Procedure 1 (2 of 3)
 Courtesy of Nissan Motor Co., U.S.A.

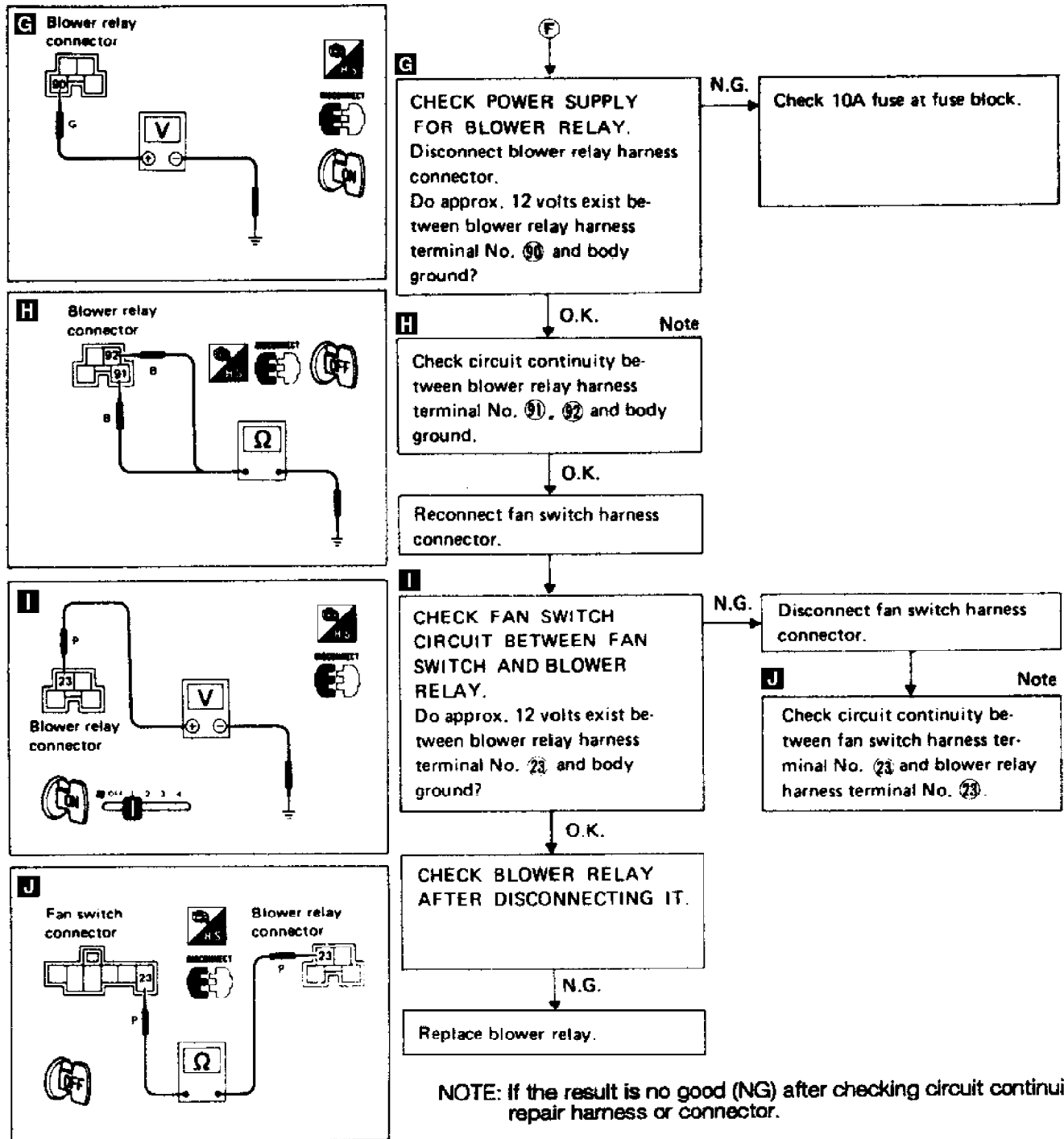

91D04815
 Fig. 9: Diagnostic Procedure 1 (3 of 3)
 Courtesy of Nissan Motor Co., U.S.A.

DIAGNOSTIC PROCEDURE 2 - AIR OUTLET DOES NOT CHANGE

See Fig. 10 and 11.

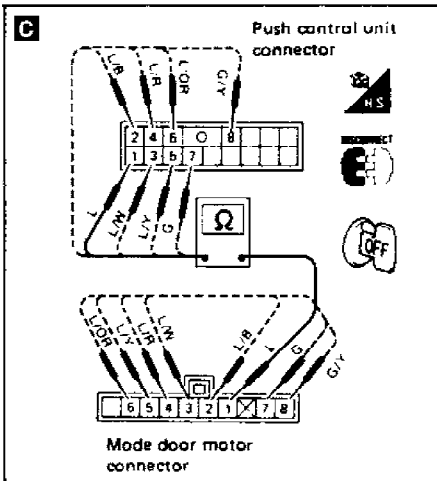
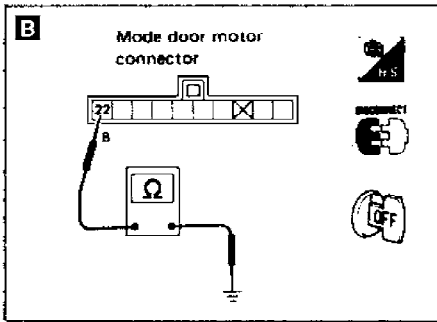
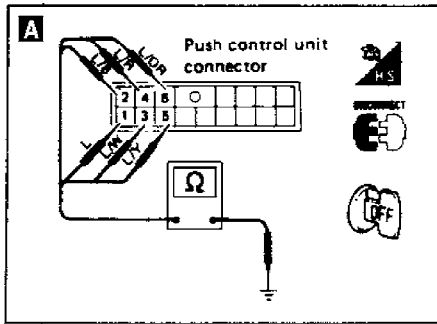

• Perform PRELIMINARY CHECK 4 and 5 before referring to the following flow chart.

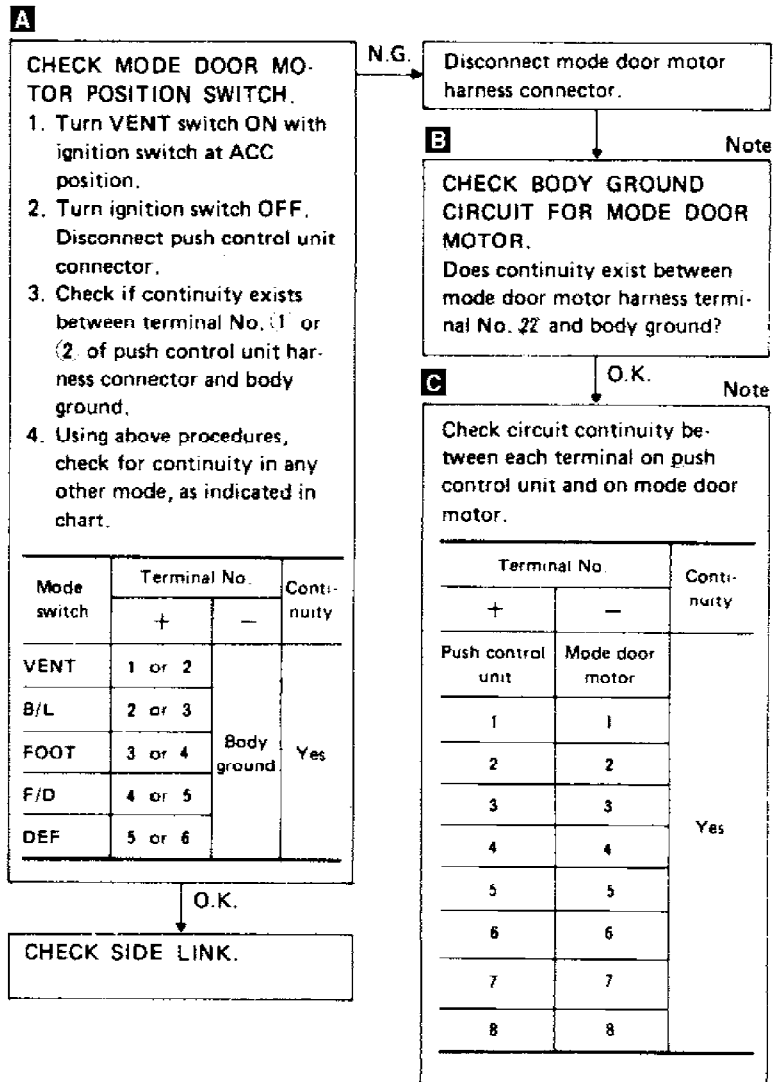

NOTE: If the result is no good (NG) after checking circuit continuity, repair harness or connector.

91F04816

Fig. 10: Diagnostic Procedure 2 (1 of 2)
Courtesy of Nissan Motor Co., U.S.A.

Perform PRELIMINARY CHECK 4 and 6 before referring to the following flow chart.

Go To Next Figure

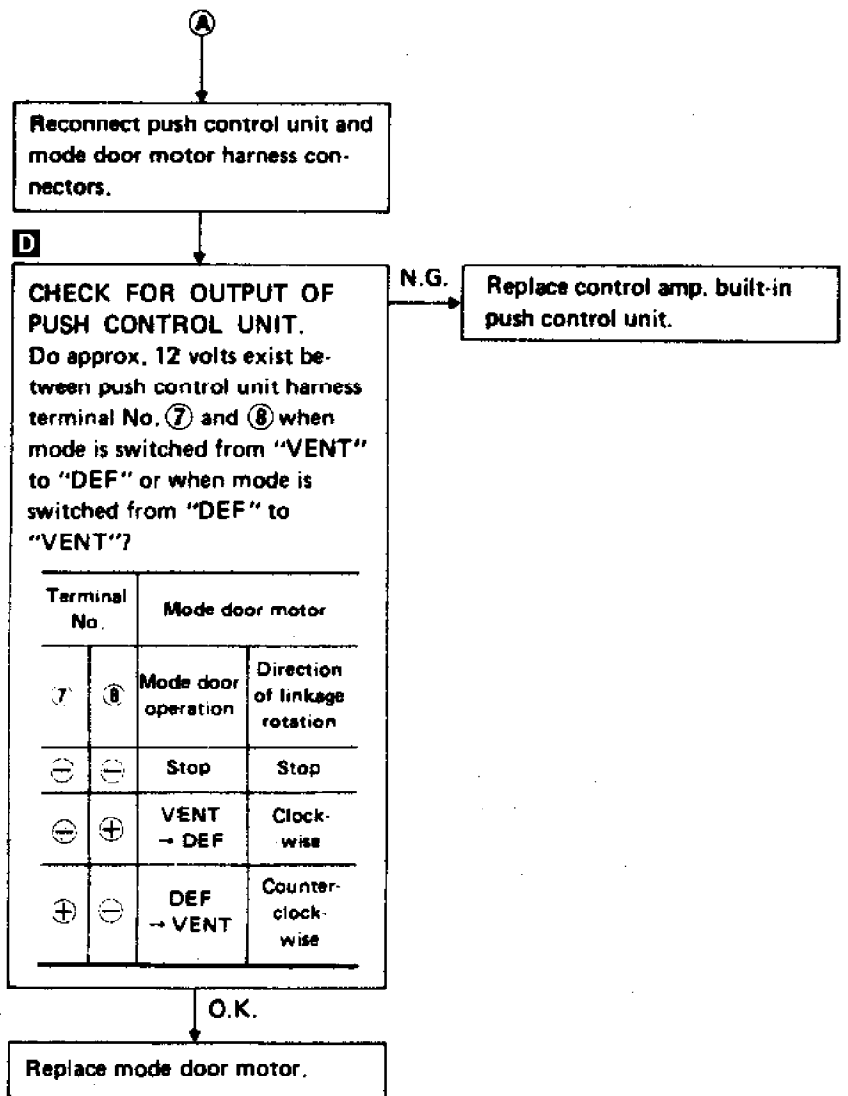
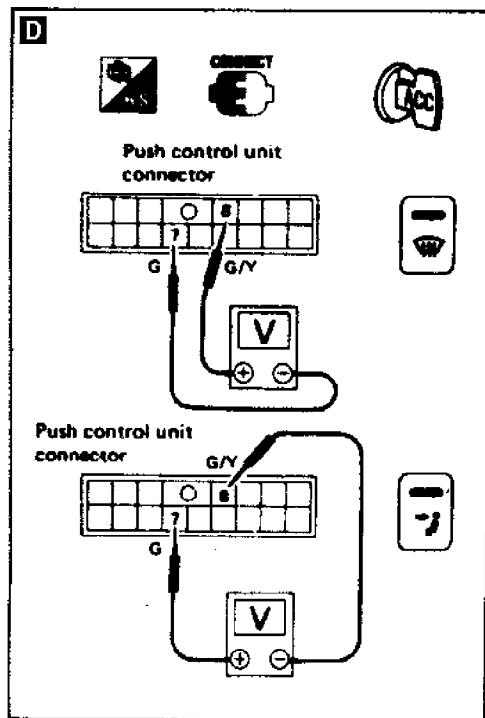

90C05635

Fig. 11: Diagnostic Procedure 2 (2 of 2)
Courtesy of Nissan Motor Co., U.S.A.

DIAGNOSTIC PROCEDURE 3 - INTAKE DOOR DOES NOT CHANGE

Intake Door Does Not Change In VENT, BI-LEVEL or FOOT Mode.
See Fig. 12.

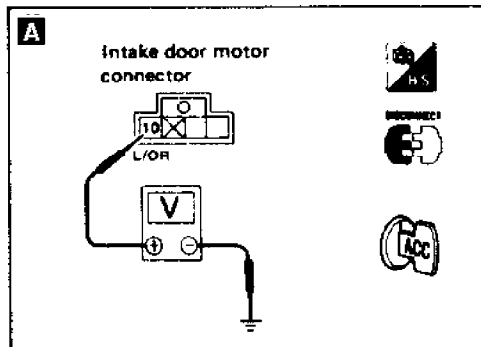

• Perform PRELIMINARY CHECK 1 and 5 before referring to the following flow chart.

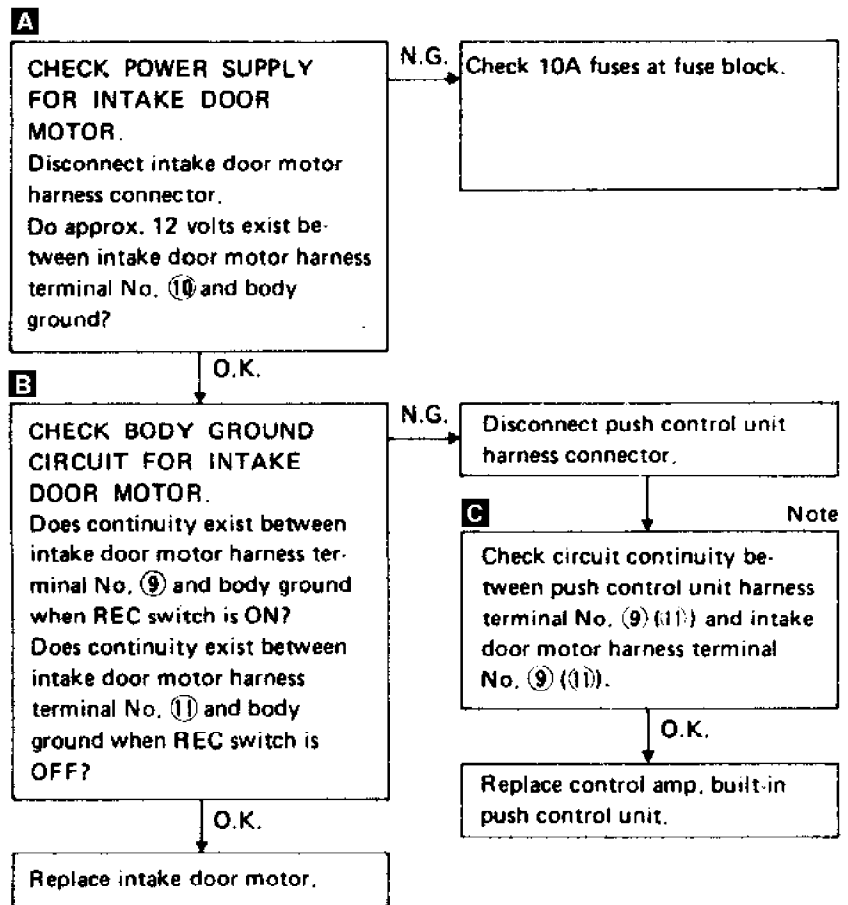
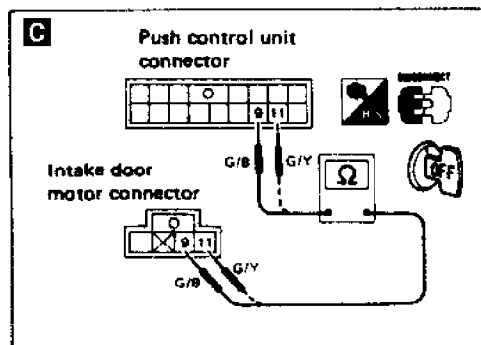
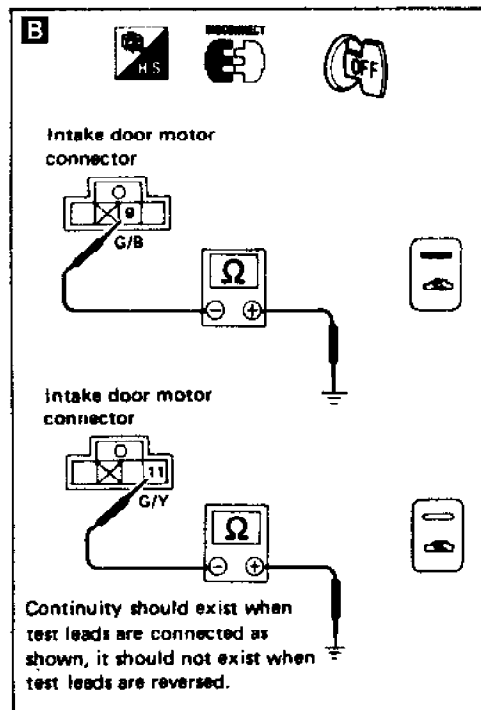

NOTE: If the result is no good (NG) after checking circuit continuity, repair harness or connector.

90E05636

Fig. 12: Diagnostic Procedure 3
Courtesy of Nissan Motor Co., U.S.A.

Perform PRELIMINARY CHECK 1 and 6 before referring to the following flow chart.

DIAGNOSTIC PROCEDURE 4 - COMPRESSOR CLUTCH DOES NOT ENGAGE

Compressor (Magnet) clutch does not engage with A/C & Fan switch on. See Figs. 13 to 17.

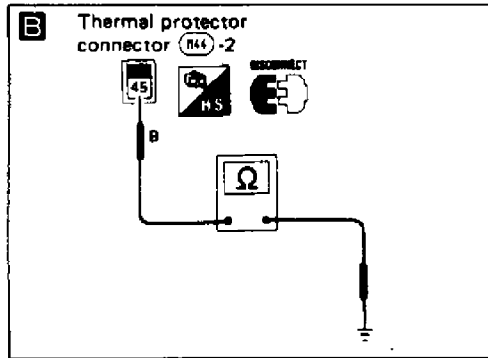
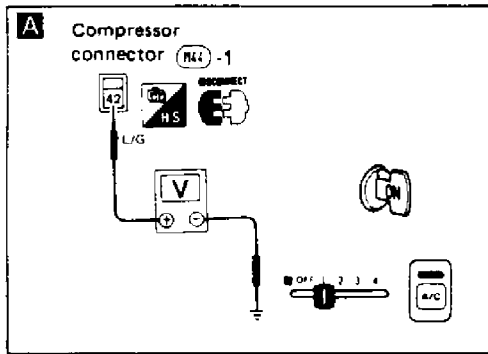

Diagnostic Procedure 4

SYMPTOM: Magnet clutch does not operate with A/C switch and fan switch are ON.

- Perform PRELIMINARY CHECK 2 before referring to the following flow chart.

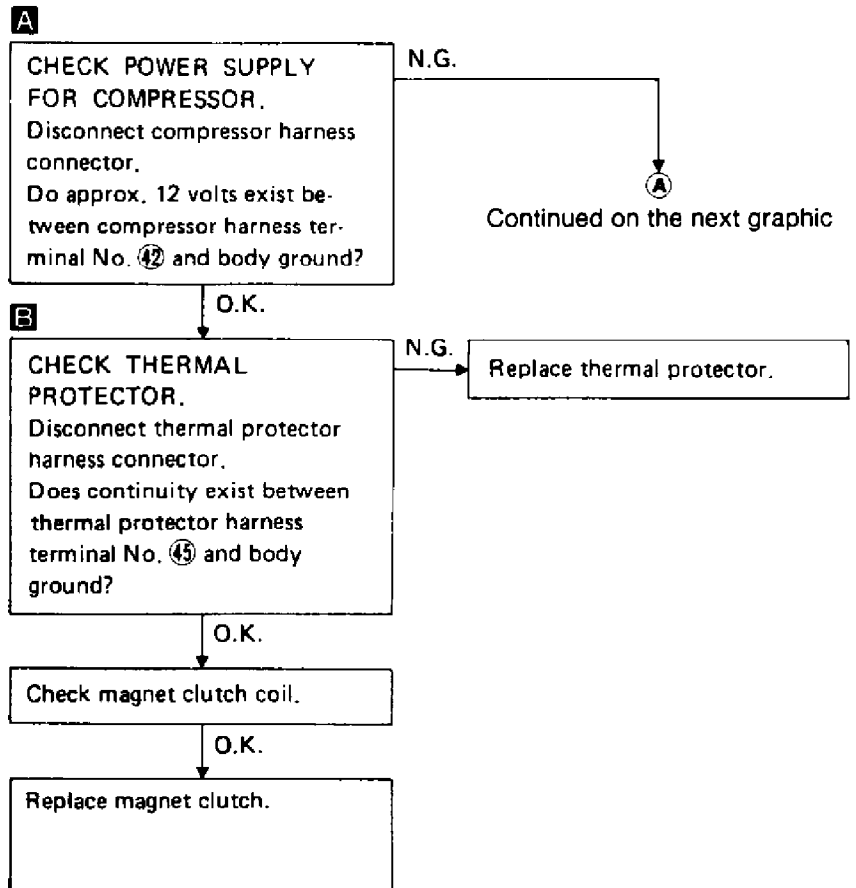
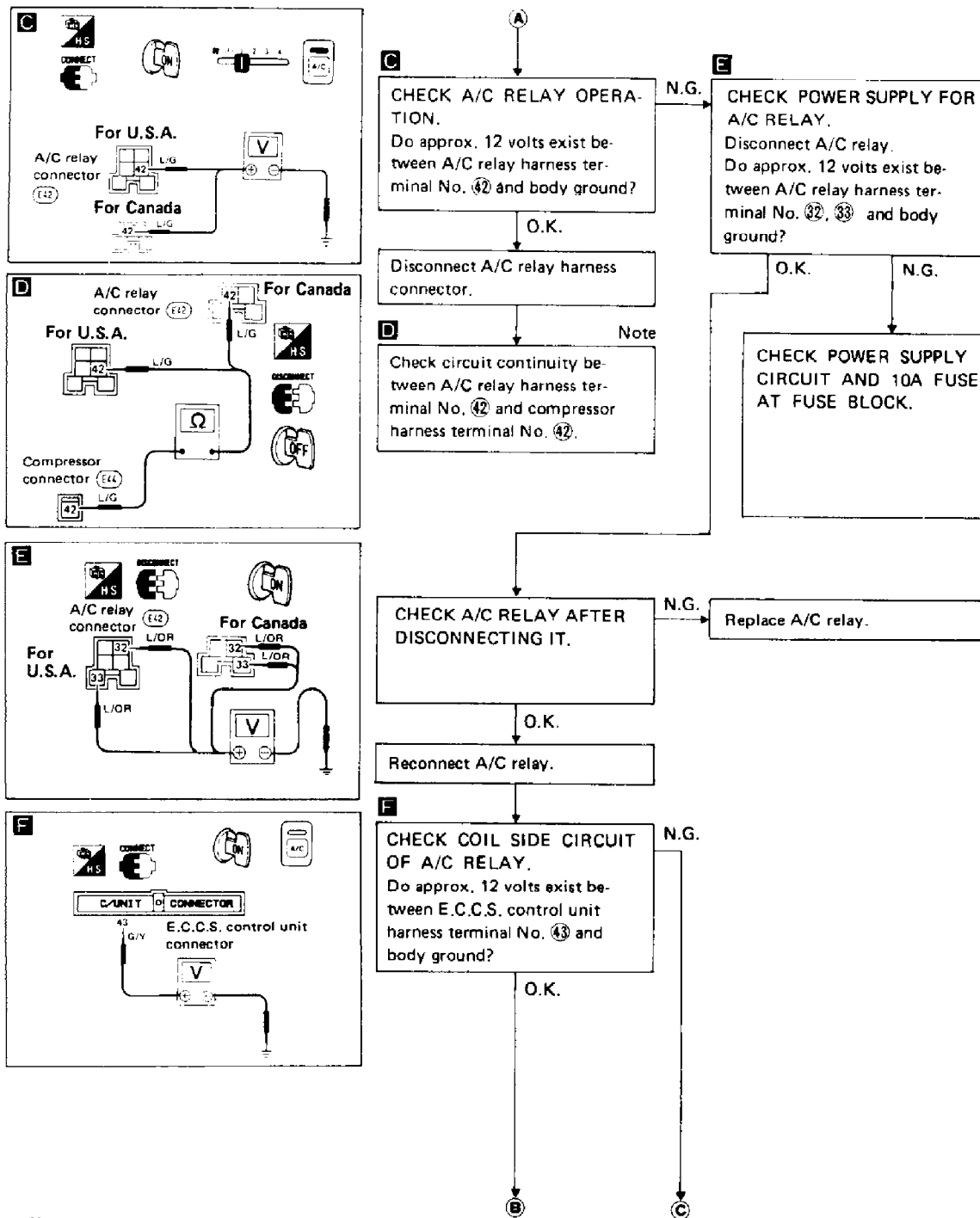
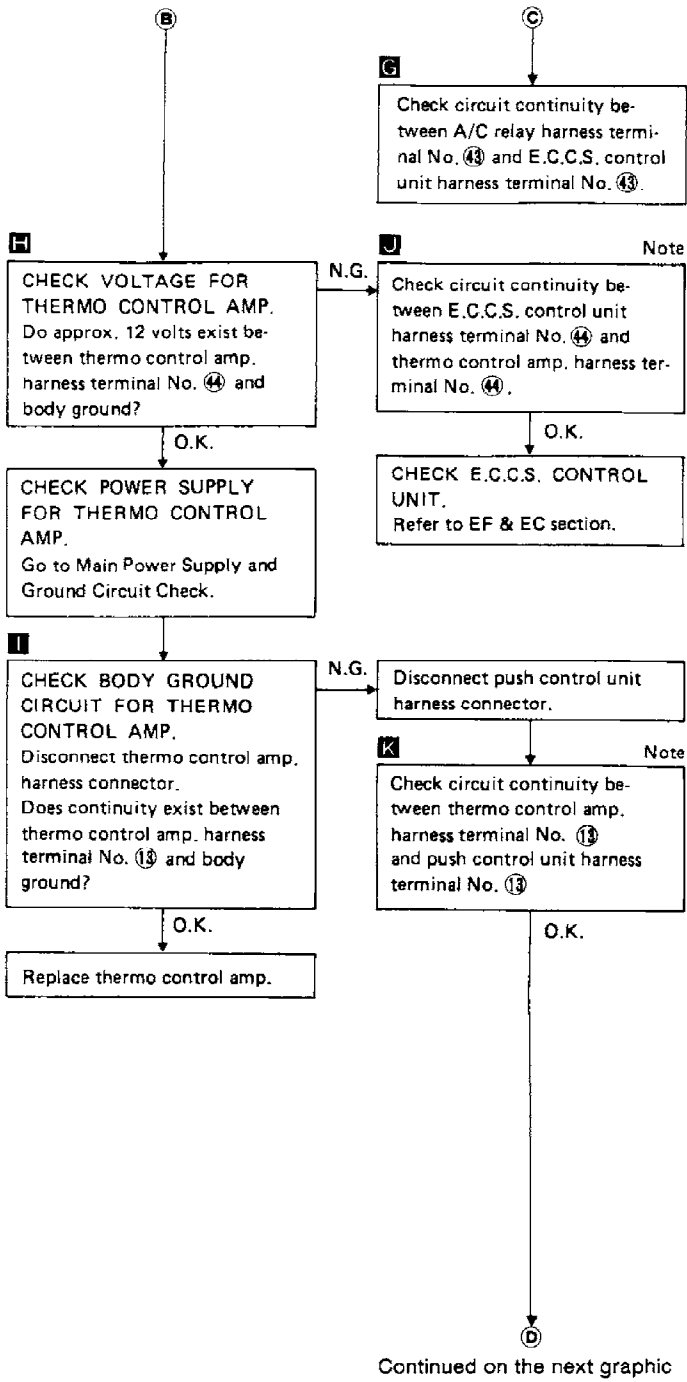
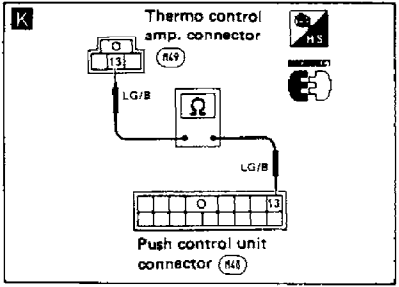
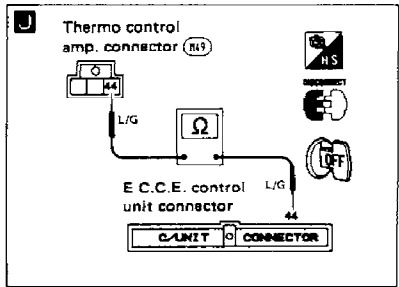
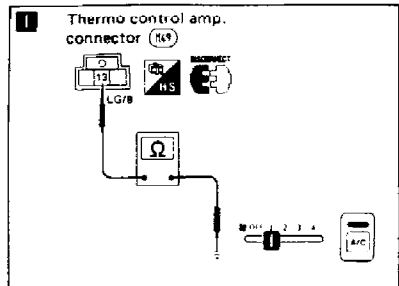
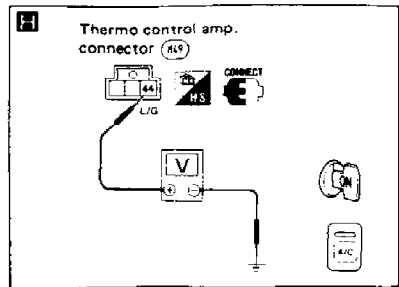
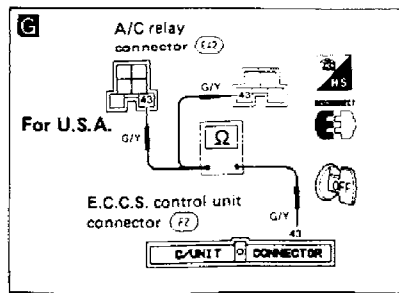

Fig. 13: Diagnostic Procedure 4 (1 of 5)
Courtesy of Nissan Motor Co., U.S.A.



Note:
If the result is N.G. after checking circuit continuity, repair harness or connector.

Fig. 14: Diagnostic Procedure 4 (2 of 5)
Courtesy of Nissan Motor Co., U.S.A.



Note:
 If the result is N.G. after checking circuit continuity, repair harness or connector.

Continued on the next graphic

Fig. 15: Diagnostic Procedure 4 (3 of 5)
 Courtesy of Nissan Motor Co., U.S.A.

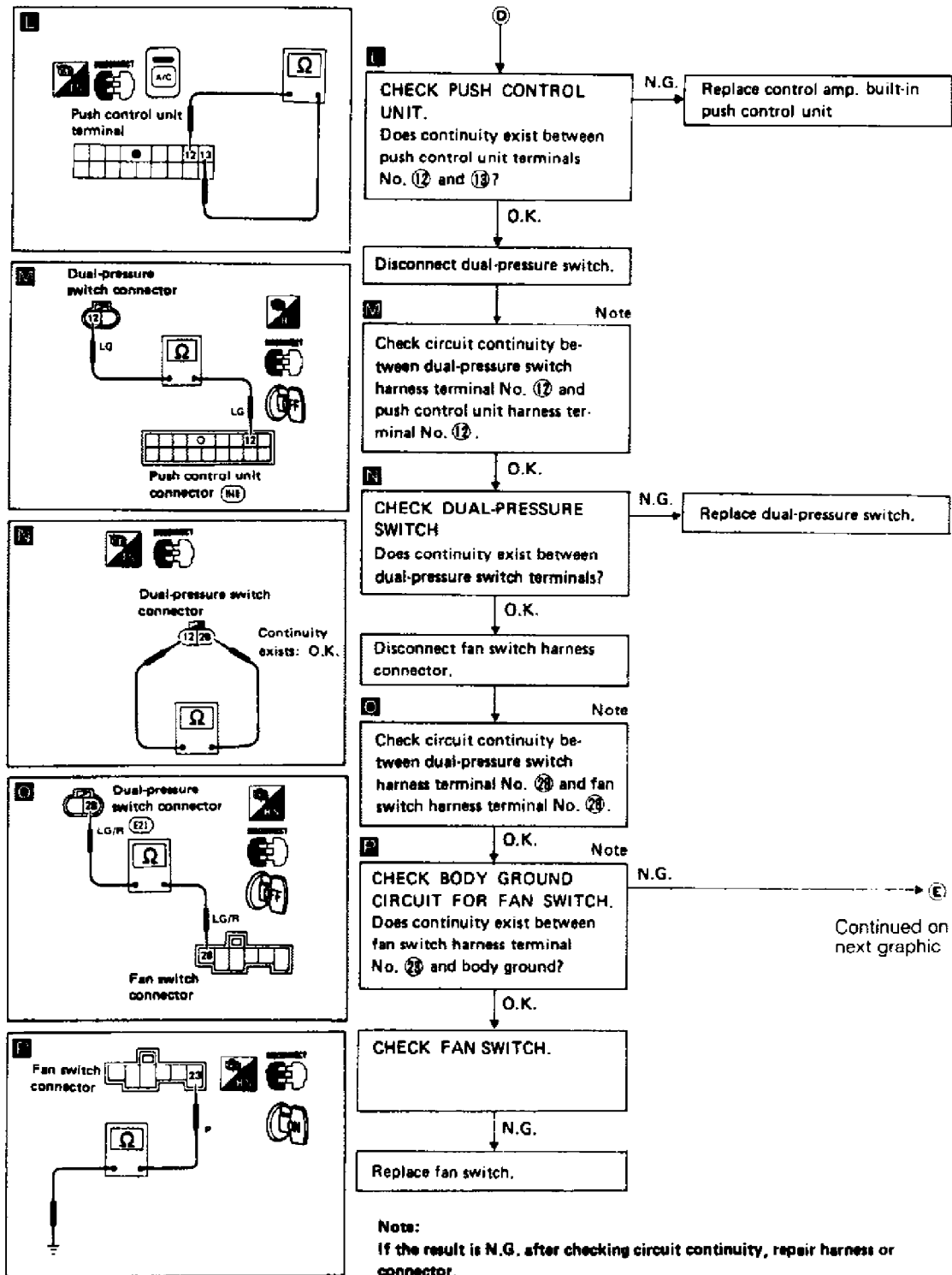

Fig. 16: Diagnostic Procedure 4 (4 of 5)
Courtesy of Nissan Motor Co., U.S.A.

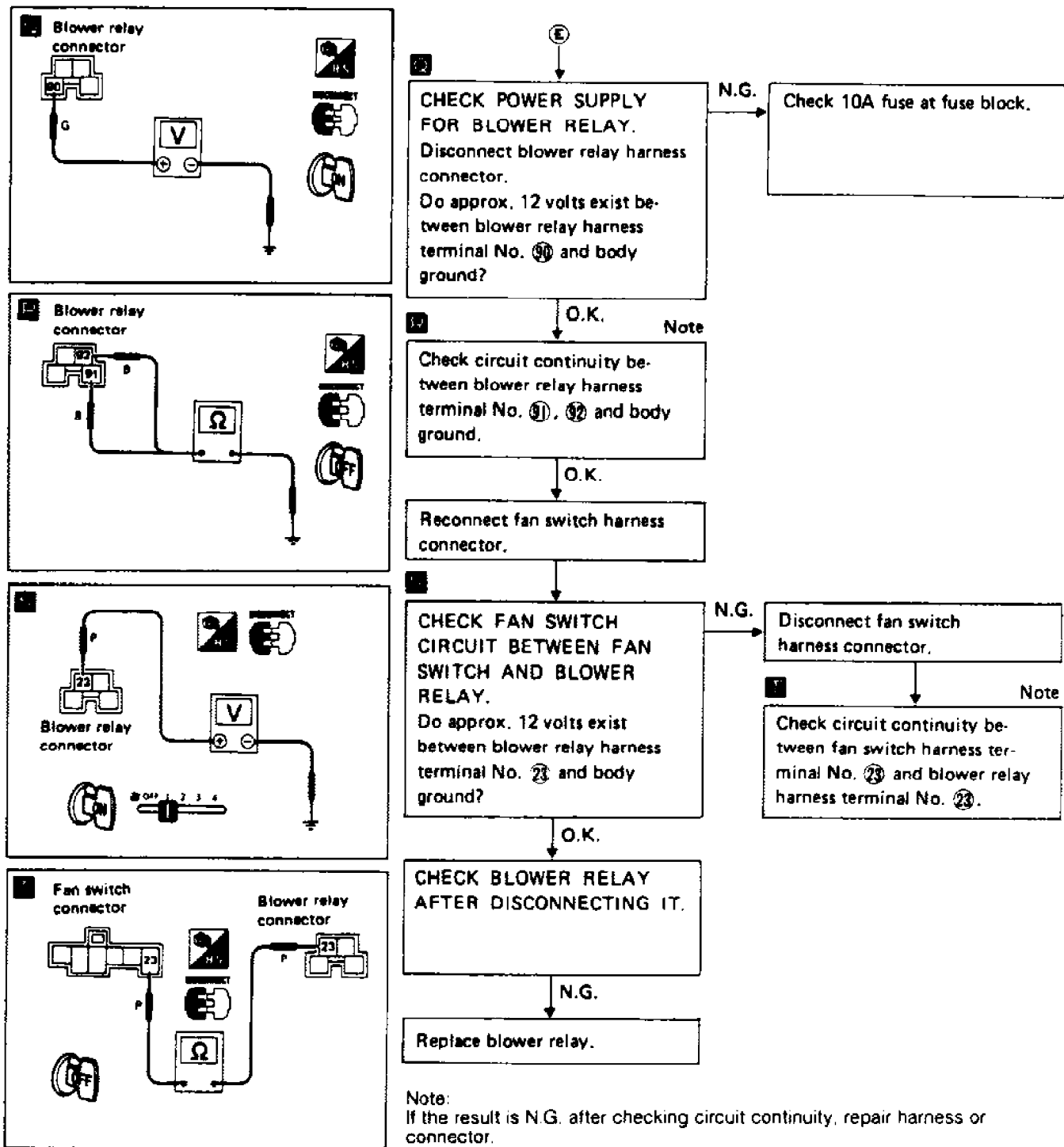
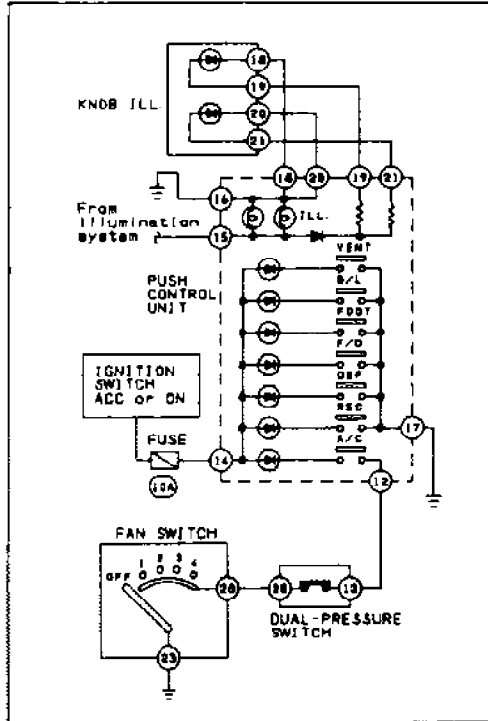

Fig. 17: Diagnostic Procedure 4 (5 of 5)
Courtesy of Nissan Motor Co., U.S.A.

DIAGNOSTIC PROCEDURE 5 - PUSH CONTROL INDICATORS DO NOT COME ON

Illumination or indicators of Push Control Unit do not come

on. See Figs. 18 to 21.



- Perform PRELIMINARY CHECK 6 before referring to the following flow chart.

Turn ignition switch and lighting switch ON.

CHECK ILLUMINATION AND INDICATORS.

- Turn A/C, REC and fan switches ON.
- Push VENT, B/L, FOOT, F/D and DEF switches in order.
- Check for incidents and follow the repairing methods as shown:

INCIDENTS								"How to repair"
ILL.	VENT	B/L	FOOT	F/D	DEF	REC	A/C	
X	○	○	○	○	○	○	△	Go to DIAGNOSTIC PROCEDURE 5-1.
△	○	○	○	○	○	○	X	Go to DIAGNOSTIC PROCEDURE 5-2.
○	X	X	X	X	X	X	△	Go to DIAGNOSTIC PROCEDURE 5-3.
△	△						△	Replace control amp. built-in push control unit.
○	X	X	X	X	X	X	○	Replace control amp. built-in push control nit.
△	X	X	X	X	X	X	○	Go to DIAGNOSTIC PROCEDURE 5-4.

○: Illumination or indicator comes on.
 X: Illumination or indicator does not come on.
 △: Some indicators for VENT, B/L, FOOT, F/D, DEF or REC come on.

Fig. 18: Diagnostic Procedure 5 (1 of 4)
 Courtesy of Nissan Motor Co., U.S.A.

Perform PRELIMINARY CHECK 6 before referring to the following flow chart.

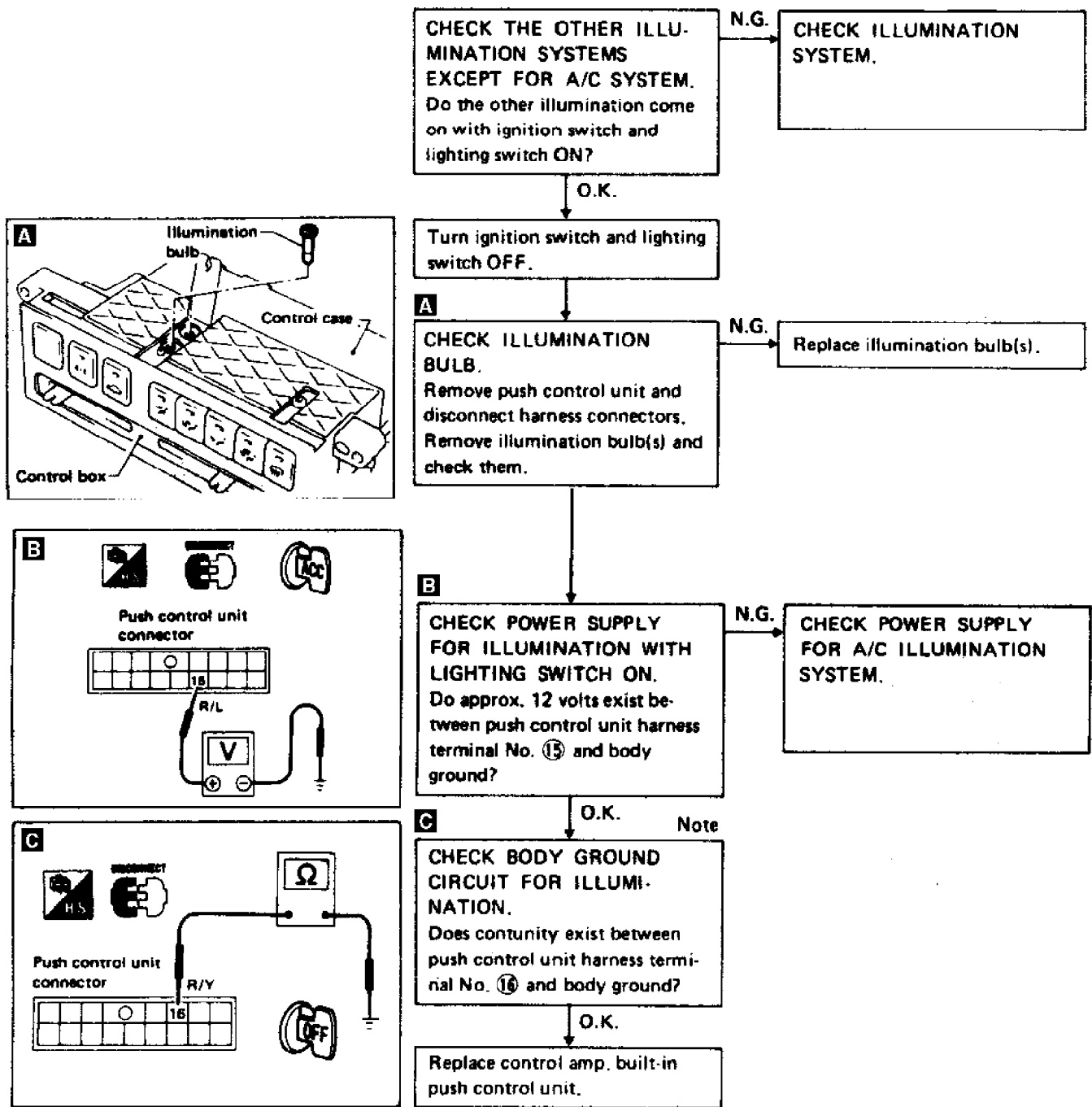

NOTE: If the result is no good (NG) after checking circuit continuity, repair harness or connector.

91D04820

Fig. 19: Diagnostic Procedure 5 (2 of 4)
 Courtesy of Nissan Motor Co., U.S.A.

DIAGNOSTIC PROCEDURE 5.

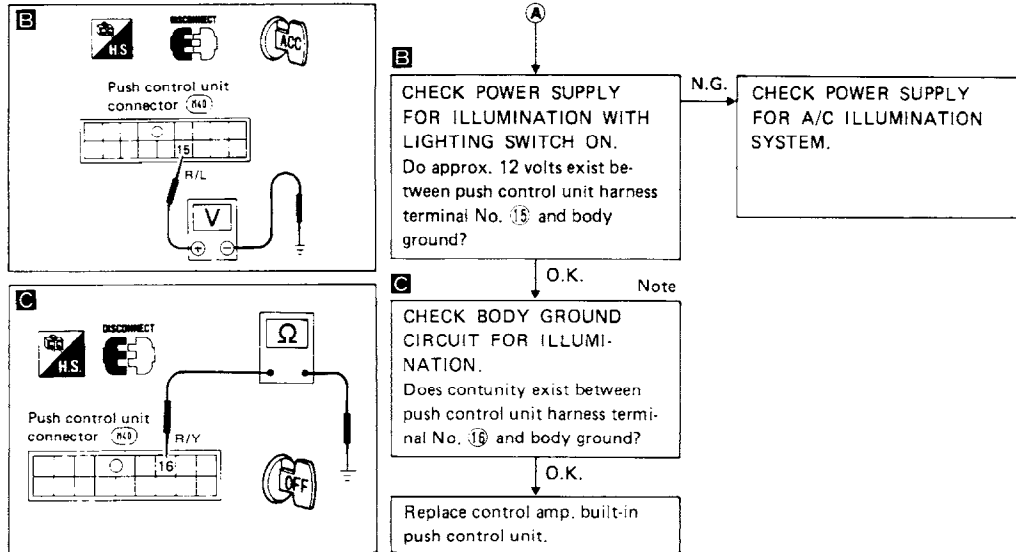

DIAGNOSTIC PROCEDURE 5-2

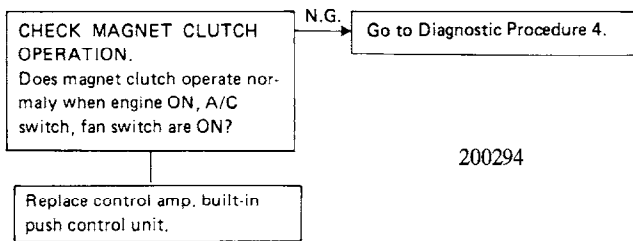

200294

Fig. 20: Diagnostic Procedures 5 (3 of 4)
 Courtesy of Nissan Motor Co., U.S.A.

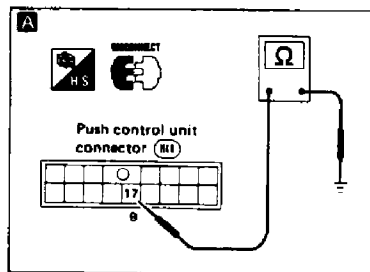
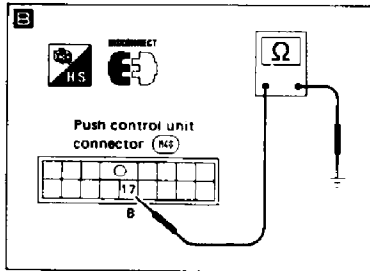
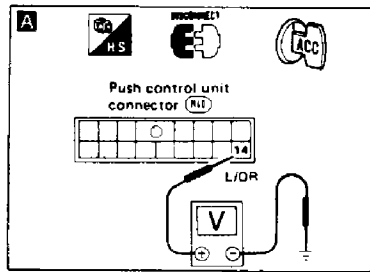

DIAGNOSTIC PROCEDURE 5-3

Turn ignition switch and lighting switch OFF.

Disconnect push control unit harness connector.

A CHECK POWER SUPPLY FOR PUSH CONTROL UNIT. Do approx. 12 volts exist between push control unit harness terminal No. (14) and body ground?

N.G. Check 10A fuse at fuse block.

B CHECK BODY GROUND CIRCUIT FOR PUSH CONTROL UNIT. Does continuity exist between push control unit harness terminal No. (17) and body ground?

O.K.

Replace control amp. built-in push control unit.

DIAGNOSTIC PROCEDURE 5-4

Turn ignition switch and lighting switch OFF.

Disconnect push control unit harness connector.

A CHECK BODY GROUND CIRCUIT FOR PUSH CONTROL UNIT. Does continuity exist between push control unit harness terminal No. (17) and body ground?

O.K.

Replace control amp. built-in push control unit.

Note:
If the result is N.G. after checking circuit continuity, repair harness or connector.

Fig. 21: Diagnostic Procedures 5 (4 of 4)
Courtesy of Nissan Motor Co., U.S.A.