

DRIVE AXLE

1990 Nissan 240SX

1990 DRIVE AXLES
Rear Axle - R200

240SX, 300ZX

DESCRIPTION & OPERATION

The axle assembly is a hypoid type gear with integral carrier housing. The pinion bearing preload adjustment is made with a spacer and washer between the front and rear bearing cones.

The differential side bearing preload and pinion depth adjustment are made by shims. Driving power is transmitted to the wheel by spline type axle shaft with CV type joints. A Limited Slip Differential (LSD) is an option on 300ZX.

AXLE RATIO & IDENTIFICATION

Nissan does not identify axles with a specific external identification marking. The R200 axle has a 200 mm ring gear pitch diameter. To determine axle ratio, divide the number of ring gear teeth by the number of drive pinion gear teeth.

AXLE RATIO SPECIFICATIONS

Application	Ratio
240SX & 300ZX	4.08

NOTE: See RWD AXLE SHAFTS article for axle shaft overhaul.

AXLE SHAFT & BEARING R & I

Removal

1) Raise and support vehicle. Cover boots with shop towel to prevent damage. Remove the side flange-to-differential bolts and separate axle shaft.

2) To remove axle shaft from outboard/wheel side, loosen axle shaft lock nut, but do not remove completely. Tap lock nut lightly with soft hammer to drive out axle shaft.

Installation

1) Install axle shafts into wheel hub and temporarily tighten wheel hub lock nut. Install axle shaft onto differential side flange. Try to pull axle shaft out of differential by hand to ensure proper engagement of snap rings.

2) Tighten wheel hub lock nut to specification. See TORQUE SPECIFICATIONS table at end of article. Replace differential fluid (if required). To complete installation, reverse removal procedure.

DRIVE SHAFT R & I

Removal

Put match marks on pinion and drive shaft flanges for reassembly reference. Remove nuts and bolts holding drive shaft to differential. Remove bolts holding center bearing support to body. Remove drive shaft and insert plug in rear of transmission extension

housing.

Installation

Align match marks made during removal. Install nuts and bolts finger tight. Turn drive shaft so that match marks are at 12 o'clock position. Carefully and evenly tighten nuts and bolts to specification. See TORQUE SPECIFICATIONS table at end of article.

PINION FLANGE & OIL SEAL R & I

Removal & Installation

Raise and support rear of vehicle. Drain differential. Disconnect drive shaft from pinion flange. See DRIVE SHAFT R & I. Remove pinion nut. Remove pinion flange with puller. Remove oil seal. To install, reverse removal procedure. Apply grease between seal lips before installation.

OUTPUT SHAFT & OIL SEAL R & I

Removal

Remove axle shaft. See AXLE SHAFT & BEARING R & I in this article. Use screwdriver or similar tool to remove seal.

Installation

Use seal installer to drive in seal. To complete installation, reverse removal procedure.

DIFFERENTIAL ASSEMBLY R & I

Removal & Installation

Raise and support rear of vehicle. Drain gear oil. Remove exhaust pipe (300ZX). Disconnect drive shaft at pinion flange. Remove axle shafts. See AXLE SHAFT & BEARING R & I in this article. Support differential on jack. Remove mounting bolts at suspension members. Remove nut on end of differential bracket. Lower assembly on jack and remove from vehicle. To install, reverse removal procedure.

NOTE: Support suspension member on a stand to prevent damage to insulators.

DIFFERENTIAL ASSEMBLY DISASSEMBLY

1) With differential assembly removed from vehicle, remove rear mounting member and cover plate. See Figs. 1 and 2. Use torque wrench to check total differential preload. Total preload should be 12-15 INCH Lbs. (1.4-1.7 N.m).

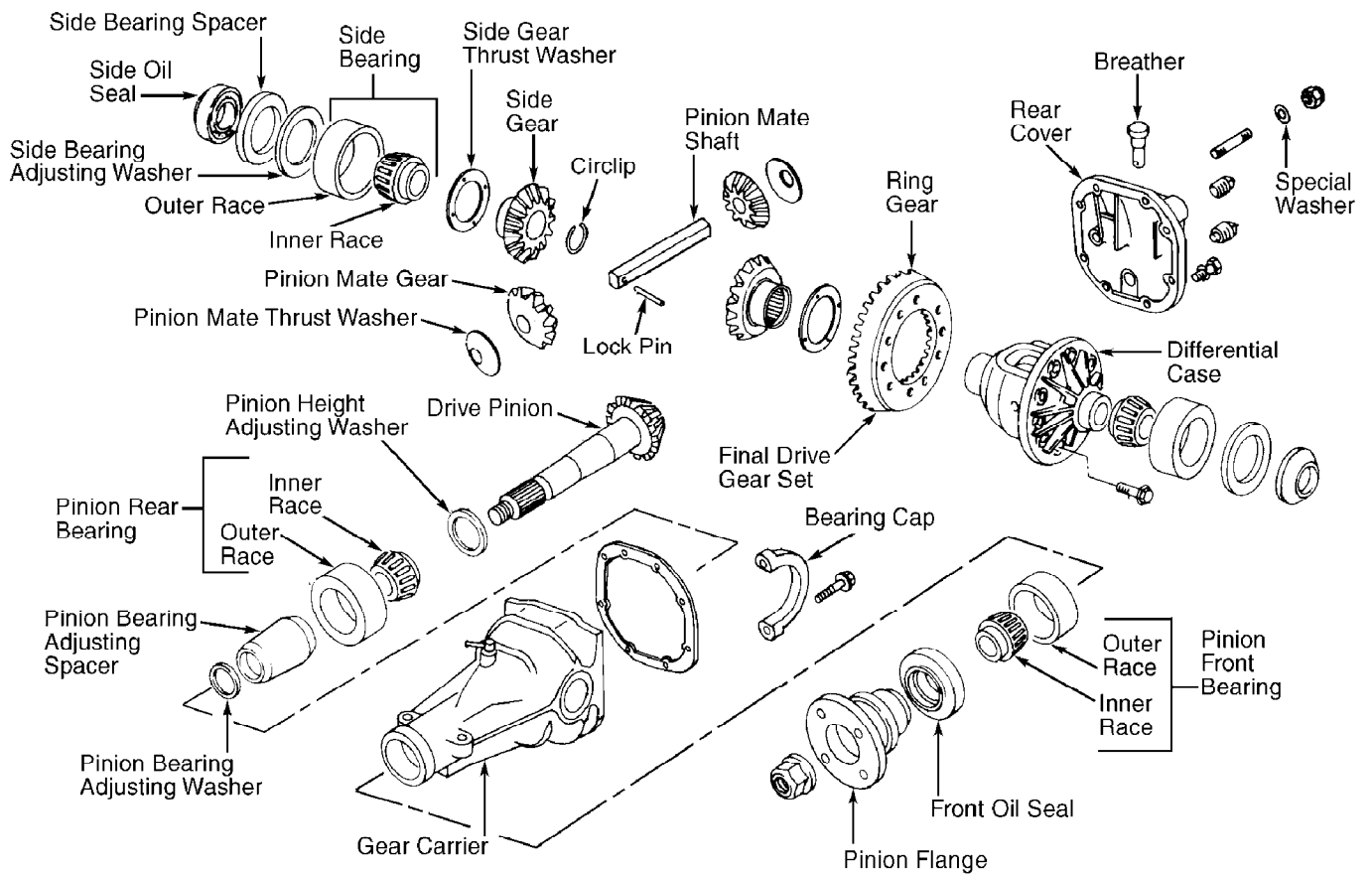

90A02344

Fig. 1: Exploded View of 240SX Differential Assembly
 Courtesy of Nissan Motor Co., U.S.A.

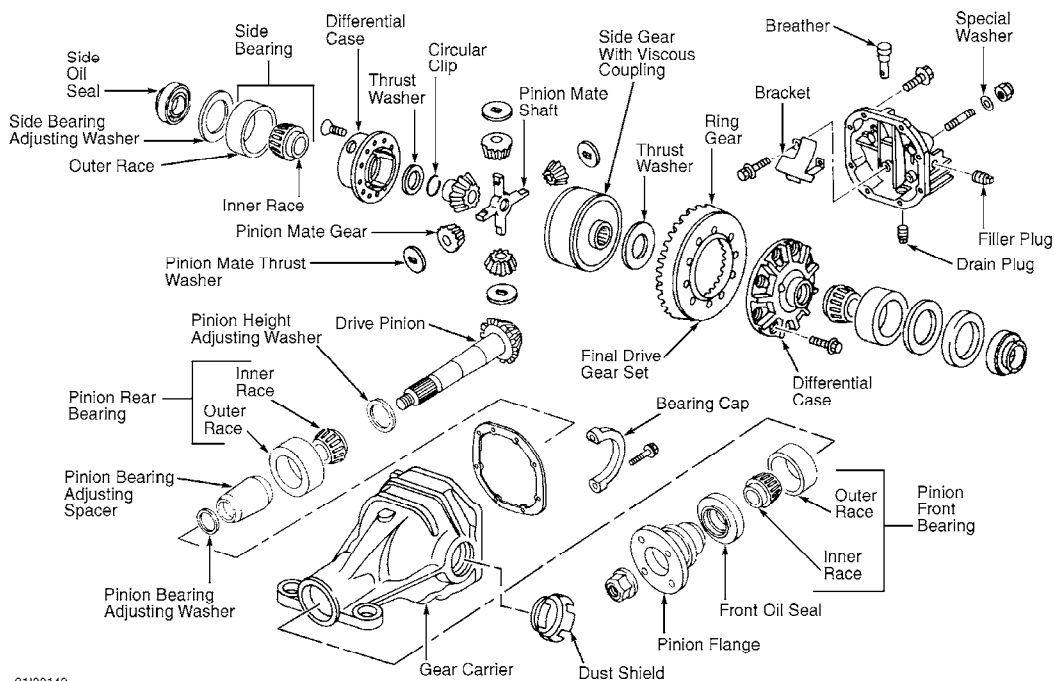

91100149

Fig. 2: Exploded View of 300ZX Differential Assembly
 Courtesy of Nissan Motor Co., U.S.A.

2) Mount dial indicator on gear carrier gasket surface. Record ring gear to pinion backlash readings at several points around ring gear for use during reassembly. Backlash should be .0039-.0059" (.10-.15 mm).

3) Place dial indicator so that it contacts ring gear surface behind tooth face. Check ring gear runout. Runout limit is .002" (.05 mm). Check ring and pinion gear tooth contact pattern. See GEAR TOOTH PATTERNS in trouble shooting.

4) On 240SX, check clearance between side gear thrust washer and differential case. Clearance should be .004-.008" (.10-.20 mm).

5) Mark carrier, caps and bearing outer races for reinstallation in original position. Remove side bearing caps. Extract differential case from carrier. Do not mix right and left side bearings or races.

6) Remove pinion nut. Remove pinion flange with puller. Using a press, remove drive pinion (together with rear bearing inner race, bearing spacer and adjusting washer) from carrier. Remove pinion oil seal. Remove front bearing inner race. Remove side oil seal.

7) Remove pinion bearing outer races using a brass drift. Remove pinion rear bearing inner race and the drive pinion height adjusting washer.

NOTE: Keep left and right side bearings separate, as they are not interchangeable.

8) To disassemble differential case, use Side Bearing Puller (ST33051001) with Driver (ST33061000) and remove side bearings.

9) Remove ring gear by unfolding lock strap and loosening bolts. Tap ring gear with soft hammer. Drive out pinion shaft lock pin from ring gear side. Remove pinion shaft, pinion gears, side gears and thrust washers.

NOTE: Mark gears and thrust washers for installation in their original positions.

CLEANING & INSPECTION

Thoroughly clean and inspect all parts for wear or damage. Check bearings for scratches pitting or flaking. Check tapered roller bearings for smooth rotation. Replace bearings as necessary.

REASSEMBLY & ADJUSTMENTS

1) Assemble pinion gears, side gears and thrust washers in original positions in differential case. Fit pinion shaft to differential case so that it aligns with lock pin holes.

2) Measure side gear-to-thrust washer clearance. See Fig. 3. Clearance should be .004-.008" (.10-.20 mm). Select thrust washer to obtain this clearance. Install pinion shaft lock pin and lock in place with punch.

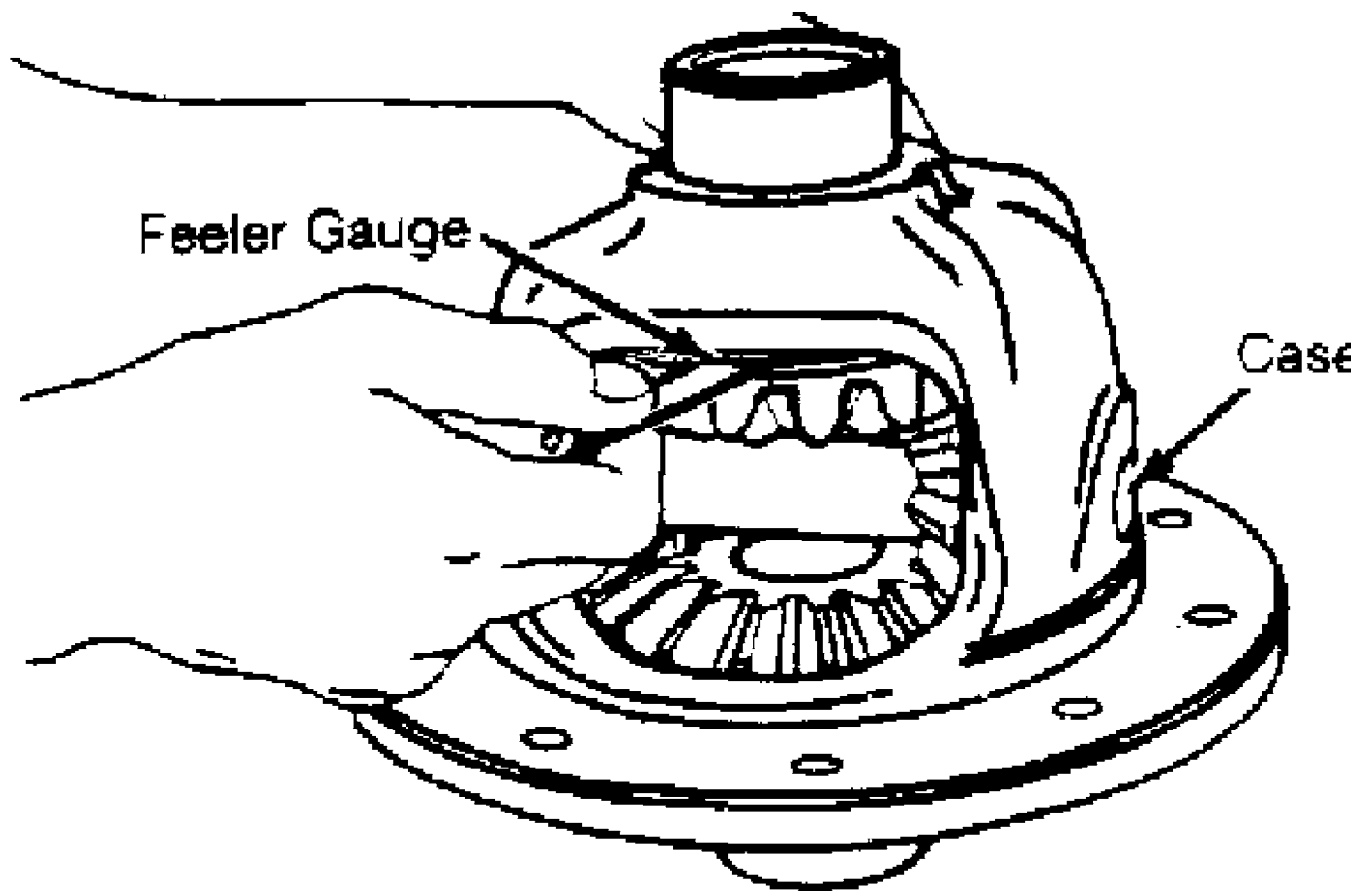

44074

Fig. 3: Measuring Side Gear-to-Thrust Washer Clearance
Courtesy of Nissan Motor Co., U.S.A.

3) Apply gear oil to gear tooth surface and thrust surfaces. Ensure gears rotate smoothly. Apply Loctite to bolt threads. Install ring gear on differential case. Install bolts and new lock washers. Tighten to specification. See TORQUE SPECIFICATIONS table at end of article.

NOTE: Tighten ring gear bolts diagonally, while tapping around bolt heads with hammer.

4) Ensure parts are clean and lubricated with light oil or Dexron type automatic transmission fluid. Place differential case, with side bearings and races installed, into gear carrier.

5) Install side bearing spacer on ring gear side of gear carrier. See Fig. 4. Using Side Bearing Spacer Drift (J-25267), install both original side bearing preload shims on the opposite side of the gear carrier from the spacer just installed.

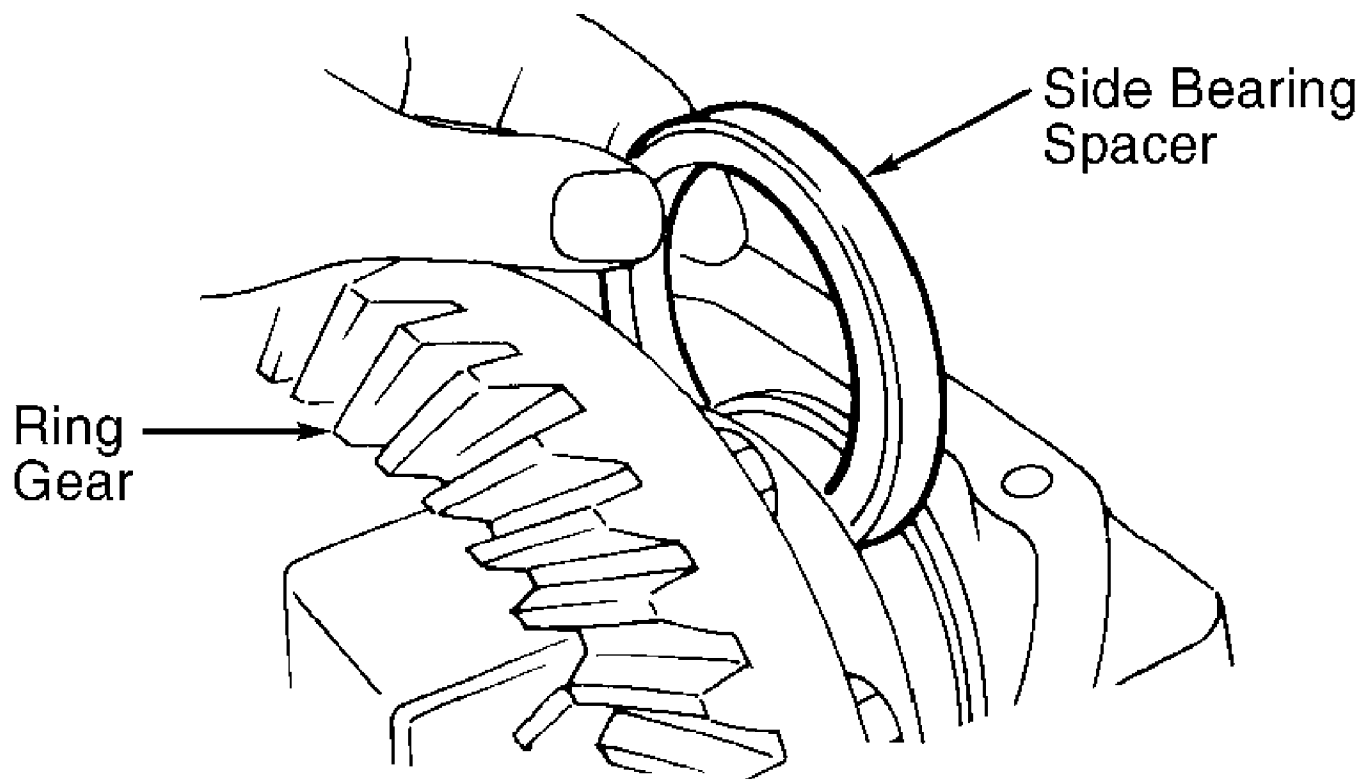

91C00150

Fig. 4: Installing Side Bearing Spacer
 Courtesy of Nissan Motor Co., U.S.A.

6) Install side bearing caps in their original location. Tighten to specification. See TORQUE SPECIFICATIONS table at end of article. Turn the ring gear several times to seat bearings.

7) Attach Spring Gauge (J-8129) to ring gear bolt. It should require 7.7-8.8 lbs. (3.5-4.0 kg) of torque to turn ring gear and assembly. Use thicker or thinner shims to obtain correct reading. After correct reading is obtained, remove ring gear/differential assembly from gear carrier and save shims for use during final assembly.

NOTE: See manufacturer's Differential Shim Selector Kit (J-34309) for complete tool and component identification.

8) Ensure parts are clean and bearings are lubricated. Install front and rear pinion bearings onto Pinion Preload Shim Selector (J-34309).

9) Ensure that Front Pinion Bearing Seat (J-34309-3) is secured tightly against the Gauge Anvil (J-34309-2). Turn Front Pinion Bearing Pilot (J-34309-5) to secure bearing in its proper position.

10) The Rear Pinion Bearing Pilot (J-34309-8) is used to center rear pinion bearing. Use Rear Pinion Bearing Locking Seat (J-34309-4) to secure bearing in tool assembly.

11) Place a .098" (2.5 mm) thick plain washer between Preload Shim Selector Components (J-34309-9) and (J-34309-16). These components must be parallel with .098" (2.5 mm) clearance.

12) Place the assembled rear pinion bearing and preload shim selector into gear carrier. See Fig. 5. Place the assembled front pinion bearing and preload shim selector into gear carrier. Screw the 2 tool and bearing assemblies together.

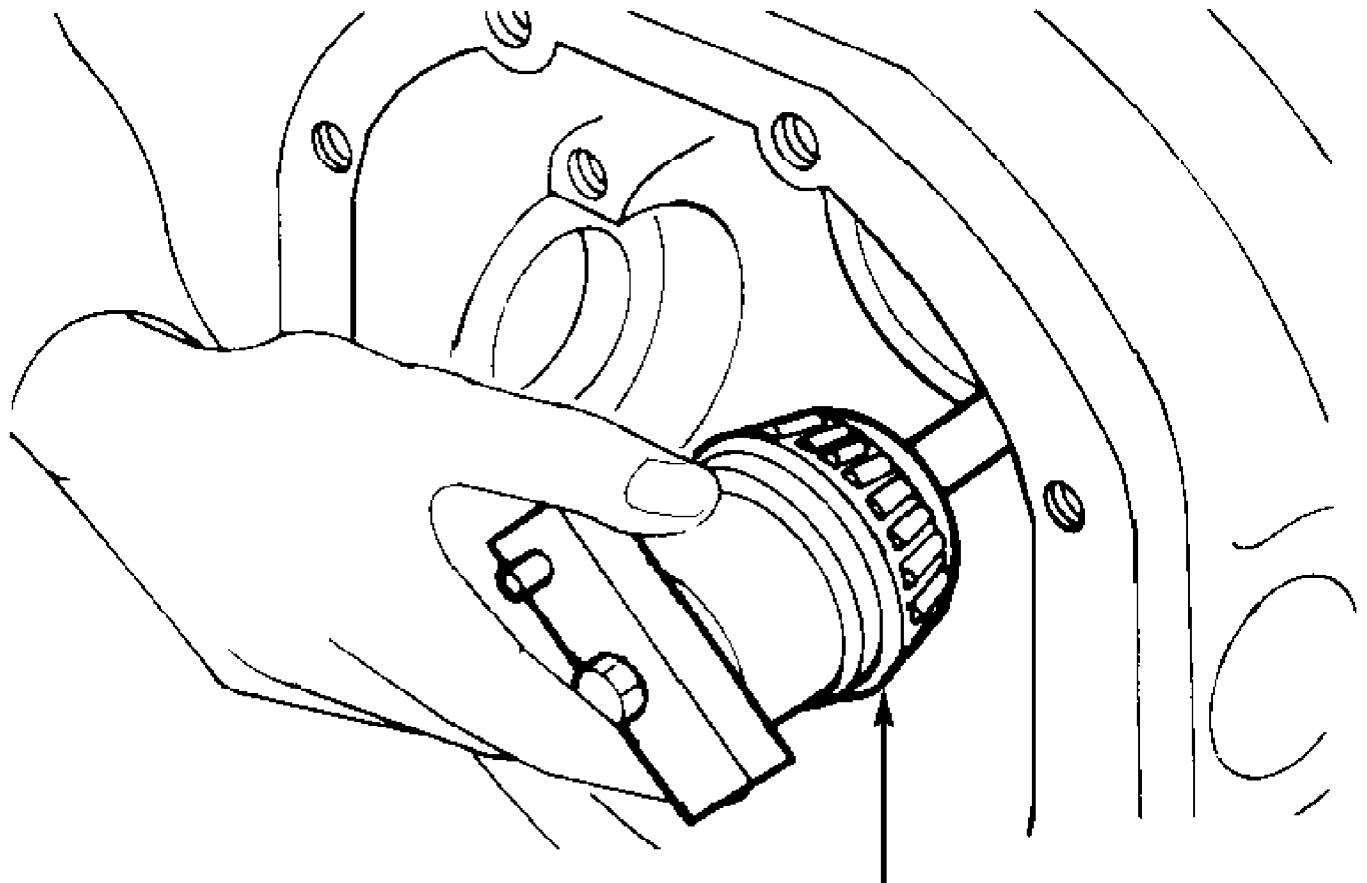

Rear Pinion Bearing

91D00151

Fig. 5: Installing Rear Pinion Bearing and Preload Shim Selector Assembly
 Courtesy of Nissan Motor Co., U.S.A.

13) Ensure that Pinion Height Gauge Plate (J-34309-16) turns a full 360 degrees. Turn assembly several times to seat bearings. Use torque wrench at end of Gauge Anvil (J-34309-2) to measure turning torque. Correct reading should be 8.7-11.3 INCH Lbs. (1.0-1.3 N.m).

14) Place pinion bearing spacer (small end first) over Gauge Anvil (J-34309-2). Seat small end of pinion bearing spacer squarely against Gauge Screw (J-34309-1). See Fig. 6.

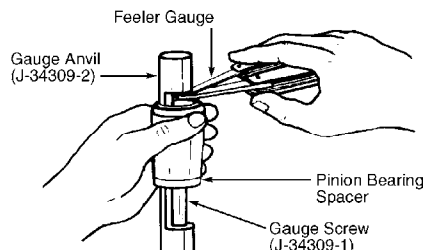

91E00152
 Fig. 6: Measuring for Drive Pinion Bearing Preload Shim Selection
 Courtesy of Nissan Motor Co., U.S.A.

15) Place a standard .138" (3.5 mm) thick feeler gauge between pinion bearing spacer and gauge screw. With another set of

feeler gauges, measure the clearance between pinion bearing and gauge screw. See Fig. 6.

16) This measurement is equal to the required drive pinion preload adjusting washer thickness. Set aside selected drive pinion preload adjusting washer for use during final assembly.

17) Position Side Bearing Discs and Arbor (J25269-4) firmly into side bearing bores. Install side bearing caps and tighten to specification. See TORQUE SPECIFICATIONS table at end of article.

18) Place a standard .12" (3 mm) thick feeler gauge between Pinion Height Adapter (J-34309-11). With another set of feeler gauges, measure between pinion height adapter and arbor. The measurement (including standard .12" (3 mm) gauge) is referred to as Standard Pinion Height measurement.

19) Record the Standard Pinion Height measurement. There is a plus (+) or minus (-) number painted on pinion gear. Refer to Corrected Pinion Height Adjustment table. Add or subtract from Standard Pinion Height measurement as directed. Select drive pinion height adjustment washer that matches this corrected figure.

CORRECTED PINION HEIGHT ADJUSTMENT

Pinion Number	Amount Added or Subtracted From Standard Pinion Height
-6	Add .0024" (.06 mm)
-5	Add .0020" (.05 mm)
-4	Add .0016" (.04 mm)
-3	Add .0012" (.03 mm)
-2	Add .0008" (.02 mm)
-1	Add .0004" (.01 mm)
0	Use Selected Washer
+1	Subtract .0004" (.01 mm)
+2	Subtract .0008" (.02 mm)
+3	Subtract .0012" (.03 mm)
+4	Subtract .0016" (.04 mm)
+5	Subtract .0020" (.05 mm)
+6	Subtract .0024" (.06 mm)

20) Remove Pinion Preload Shim Selector (J-34309) and pinion bearings assembly. Remove bearings from tool assembly for final assembly.

NOTE: Whenever side gears or pinion mate gears are replaced, thrust washers should be replaced.

21) Clean and lubricate gears. Install previously removed thrust washer on right side gear. Select a thrust washer (for measurement purposes) and install on left side gear. Using 2 screws, temporarily tighten differential case.

22) Position differential assembly with right side gear upward. Insert 2 .0012" (.03 mm) feeler gauges 180 degrees apart, between right side gear and thrust washer. See Fig. 7.

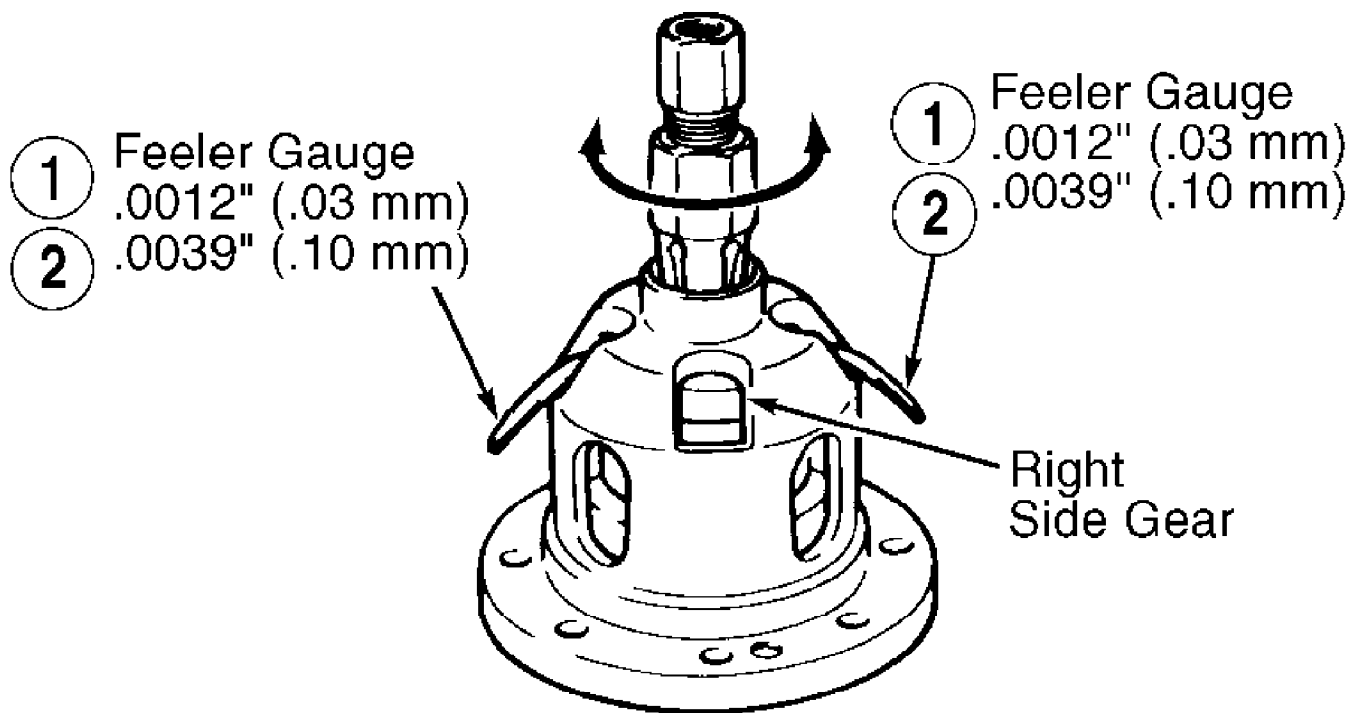

91F00153

Fig. 7: Measuring for Side Bearing Thrust Washer Selection
Courtesy of Nissan Motor Co., U.S.A.

23) Attempt to rotate right side gear. If gear cannot be rotated, replace LEFT side gear thrust washer with a thinner one. Replace .0012" (.03 mm) feeler gauges with .0039" (.10 mm) thick feeler gauges.

24) Right side gear should not be able to rotate with thicker feeler gauges in place. If it does rotate, replace left side gear thrust washer with a thicker one so that right side gear will not rotate.

25) Select thrust washers as necessary to ensure that both side gears can rotate while the thinner feeler gauges are in place and side gear is stationary with thicker feeler gauges in place.

FINAL ASSEMBLY

1) Assemble differential case with selected thrust washers, side gears etc. Apply thread locking compound to ring gear bolts and install ring gear. Tighten bolts in a crisscross pattern to specification. See TORQUE SPECIFICATIONS table at end of article.

2) Press side bearing inner cones onto differential case. Install selected drive pinion height adjustment washer on drive pinion shaft and press pinion rear bearing cone onto drive pinion shaft.

3) Pack bearings with multi-purpose grease. Place pinion front bearing inner cone in front of gear carrier. Assemble drive pinion, pinion bearing adjusting spacer and pinion bearing adjusting washer. Press into gear carrier until drive pinion just touches bearing.

4) Apply multi-purpose grease to front pinion bearing seal lips and install in gear carrier using seal installer. Clean oil and grease from threaded portion of drive pinion. Install pinion flange and tighten nut to specification. See TORQUE SPECIFICATIONS table at end of article.

5) Check pinion bearing preload. Pinion preload should be 9.5-12.2 INCH Lbs. (1.1-1.4 N.m). Correct as necessary with thicker or thinner pinion bearing adjusting washer.

6) Install differential case assembly. Insert selected side bearing adjusting washers. Using Side Bearing Spacer Drift (J-26233), drive in side bearing spacer. Align side bearing cap match marks and install caps. Tighten to specification. See TORQUE SPECIFICATIONS table at end of article.

7) Apply multi-purpose grease to side bearing seal lips and install in gear carrier using seal installer. Mount dial indicator and measure ring gear backlash. Backlash should be .0039-.0059" (.10-.15 mm).

8) If backlash is too great, decrease the thickness of left shim and increase the thickness of the right shim by the same amount, so that total shim thickness remains the same.

9) If backlash is too small, decrease the thickness of right shim and increase the thickness of the left shim by the same amount, so that total shim thickness remains the same.

NOTE: If total shim thickness is altered, side bearing preload will be changed.

10) Turn drive pinion several times to seat bearings. Using torque wrench on drive pinion nut, check total preload. Total preload should add 2.6 INCH Lbs. to pinion bearing preload measurement made in final assembly Step 5).

11) If total preload is too great, decrease the thickness of left shim and right shim by the same amount, so that both sides are reduced by the same amount.

12) If total preload is too small, increase the thickness of right shim and increase the thickness of the left shim by the same amount, so that both sides are increased by the same amount.

NOTE: If right side to left side shim relation is altered, ring gear-to-drive pinion backlash will be changed.

13) Recheck ring gear-to-drive pinion backlash as in final assembly Step 7). Reposition dial indicator to contact ring gear behind tooth surface and measure ring gear runout. Runout limit is .002" (.05 mm).

14) If backlash varies excessively in different places, foreign material may be caught between ring gear and differential case. If backlash varies greatly when runout is within specification, replace hypoid gear set and/or differential case.

15) Check tooth contact pattern. Install rear cover and gasket. To complete installation, reverse removal procedures.

TORQUE SPECIFICATIONS

TORQUE SPECIFICATIONS

Application	Ft. Lbs. (N.m)
Drain & Fill Plugs	
240SX	43-72 (58-98)
300ZX	29-43 (39-58)
Drive Pinion Nut	137-217 (186-294)
Drive Shaft-to-Pinion	
Flange Bolts	29-33 (39-45)
Rear Cover Bolts	
240SX	12-17 (16-23)
300SX	29-36 (39-49)

Rear Cover-to-Mount Bolts	65-87	(88-118)
Ring Gear Bolts		
240SX	(1) 98-112	(132-152)
300ZX	(1) 94-145	(127-197)
Side Bearing Cap Bolts	65-72	(88-98)
Wheel Hub Lock Nut		
240SX	174-231	(235-313)
300ZX	152-203	(206-275)

(1) - Apply Loctite on bolt threads. Tighten in crisscross pattern.
